

ASSEMBLY INSTRUCTION
NGEN STAR H1-3.7-E / 6.0-E

Table of Contents

1.	Hints for this Manual	4
1.1.	Range of Validity	4
1.2.	Target Group	4
1.3.	Used Symbols	4
2.	Safety.....	5
2.1.	Proper Use of the Product.....	5
2.2.	Note on the installation of protective devices	6
2.3.	Surge Protection Devices (SPDs) for photovoltaic installations	7
3.	Introduction	7
3.1.	Basic Features	7
3.2.	System connection diagram	8
3.3.	Working Modes	9
3.4.	Dimensions.....	10
3.5.	Inverter connections	10
4.	Technical Specifications	11
4.1.	PV-Input	11
4.2.	Battery-Input.....	11
4.3.	AC-Output/-Input	11
4.4.	EPS-Output	12
4.5.	Efficiency and Protection	12
4.6.	General Data	13
5.	Installation	14
5.1.	Scope of delivery	14
5.2.	Mounting guidelines	14
5.3.	Required tools	15
5.4.	Assembly steps	16
6.	Electrical Connection	17
6.1.	Connection of the PV strings	17
6.2.	Connecting the Battery	19
6.3.	AC-Connection to the Grid	20
6.4.	Connecting the loads to the EPS output.....	22
6.5.	Connecting the inverter to an earthing system.....	24
6.6.	Integration of other generating devices in emergency power operation	25
6.7.	Connection WIFI/LAN/4G-Dongle	26
6.8.	Inverter Communication Connection	27
6.8.1.	Communication Connection using the Smart Box.....	27
6.8.2.	Communication Connection without Smart Box only with Synaptic and Smart Meter	28
6.9.	Configuration of the used measuring device (Smart Meter / CT) in the inverter menu	29

6.10.	Combination of NGEN-STAR inverters with an existing generation system	30
6.10.1.	Wiring diagram using the Smart Box.....	30
6.10.2.	Wiring diagram without Smart Box only with Synaptic and Smart Meter	31
6.11.	Set up of the second Smart Meter	32
6.12.	DRM/E-Stop-Interface	33
6.12.1.	Connection Diagram for the E-Stop Function using the Smart Box.....	34
6.13.	Inverter Start-up.....	34
6.14.	Software Upgrade	35
7.	Operation.....	37
7.1.	Control Panel.....	37
7.1.	Function Tree	38
8.	Connecting of an Existing Photovoltaic System to the NGEN Star System	39
8.1.	Connection to „LOAD“ on the Smart Box	39
8.2.	Connection of the Existing Photovoltaic system to NGEN Hybrid Inverter	39
9.	Synaptic-Unit part of Smart Box – Function of the relay outputs	40
9.1.	Relay 1 – Boost Mode.....	40
9.2.	Relay 2 – Load Reduction Mode	41
9.3.	Relay 3 – Production Control.....	41
10.	Configuration of the Relais in the Smart Grid Connect App	42
10.1.	Synaptic Relay Specifications	43
10.2.	Schematic Diagram of Connections (Smart Box Type A and Type B)	43
11.	Maintenance	44
11.1.	Alarm List	44
11.2.	Troubleshooting and Regular Maintenance	51
12.	Shutdown	52
12.1.	Switching off the inverter.....	52
12.2.	Inverter Dismantling.....	52
12.3.	Packaging	52
12.4.	Storage and Transport.....	52
13.	Attachment.....	53
13.1.	Example of integrating the NGEN-Star Hybrid System in a Household	53
13.2.	Connection of the NGEN-Star Hybrid Inverter-H1 with the Smart Box	54
13.2.1.	AC-Connection Diagram	54
13.2.2.	DC-Connection Diagram	54
13.2.3.	Communication-Connection Diagram.....	55

ENGLISH

Read this installation instruction carefully before installation. Failure to do so may result in personal injury and damage to property or invalidate the warranty and product guarantee. Installation requires specialist knowledge and may therefore only be carried out by appropriately qualified and authorized specialists!

The general handling of the product, its use or the exact installation methods are beyond the control of NGEN. Therefore, NGEN cannot accept any responsibility for damages, losses or cost resulting from improper installation, improper handling of the incorrect use!

1. Hints for this Manual

1.1. Range of Validity

The document describes the installation, commissioning, maintenance and troubleshooting for the following inverter model: NGEN STAR-H1-3.7-E NGEN STAR-H1-6.0-E





Note: Please keep these instructions in a place where they are always accessible.

1.2. Target Group



This manual is intended for qualified electricians. The tasks described in this manual can only be performed by qualified electricians.





1.3. Used Symbols

The following types of safety instructions and general information appear in this document as described below:

	Danger! "Danger" indicates a hazardous situation which, if not avoided, will result in death or serious injury.
	Warning! "Warning" indicates a hazardous situation which, if not avoided, could result in death or serious injury.
	Caution! "Caution" indicates a hazardous situation which could result in minor or moderate injury if not avoided.
	Note! "Note" provides important tips and instructions.

This section explains the symbols shown on the inverter and the type of plate:

	Symbol Explanation CE-Mark. The inverter complies with the requirements of the applicable CE directives.
	Caution, hot surface! The inverter may heat up during operation. Avoid contact with the inverter during operation.
	Danger of high voltage! High voltage inside the inverter is life-threatening!

	Danger! Electric shock hazard!
	Danger to life due to high voltages! There is residual voltage in the inverter that requires 5 minutes to discharge. Wait 5 minutes before opening the top cover or DC cover.
	Read the manual.
	The product must not be disposed of as household waste.
	Protective earth connection

2. Safety

2.1. Proper Use of the Product

- The inverters have been developed and tested in accordance with international safety standards. However, certain safety procedures and measures must be followed during the installation and use of the inverter. The installer must read and follow all instructions, cautions and warnings in this installation manual.
- All work, including transport, installation, commissioning, and maintenance of the device, must be performed by qualified and properly trained personnel.
- Electrical installation and maintenance of the inverter must be carried out by a licensed electrician and must comply with the local wiring rules and regulations.
- Check the device before installation to ensure that it has not suffered any transportation or handling damage that could affect the integrity of the insulation or the safety distances. Select the installation location carefully and comply with the prescribed installation guidelines. Unauthorised removal of necessary protections, improper use of the device, improper installation and operation of the device can cause serious safety hazards and risk of electric shock or equipment damage.
- Before connecting the inverter to the electricity distribution grid, the necessary permits for connection must be obtained from the local electricity distribution operator. Connection to the distribution network may only be carried out by properly trained and qualified personnel.
- Do not install the equipment in unsuitable environments such as near flammable or explosive substances, in corrosive or desert environments, or in environments where the device would be exposed to extremely high or low temperatures, or where there is a high humidity.
- Do not use the equipment if the safety devices are not working or are deactivated.
- During the installation of the device, use personal protective equipment, including gloves and eye protection.
- In case of non-standard conditions for the installation of the device, inform the manufacturer.
- Do not use the device if operating anomalies are detected. Avoid temporary repairs of the device.
- All repairs are only allowed to be carried out with approved replacement parts, which must be installed according to their intended use and by licensed electrical partners or an authorized service technician.

- Liabilities arising from commercial components are delegated to their respective manufacturers.
- Whenever the inverter has been disconnected from public grid, please proceed with extreme caution as some components may retain a sufficient charge and create a shock hazard. Before touching any part of the inverter, make sure that the surfaces and equipment are under safe touch temperatures and voltage potentials before proceeding.

2.2. Note on the installation of protective devices

In every PV system, several elements contribute to the residual current to protective earth (PE). These elements can be divided into two main types.

– **Capacitive-Leakage-Current**

The leakage current is mainly generated by the parasitic capacitance of the PV modules towards the grounding conductor. The module types, weather conditions (rain, humidity, etc.), and even the distance of the modules from the roof can affect the discharge current. Other factors that can contribute to parasitic capacitance are the internal capacitance of the inverter with respect to the grounding conductor and external protective elements such as lightning protection.

– **During Operation**

The DC bus is connected to the alternating current grid via the inverter. Thus, a portion of the alternating voltage amplitude reaches the DC bus. The fluctuating voltage constantly changes the charge state of the parasitic PV capacitor (i.e., capacitance to PE). This process is associated with a displacement current, which is proportional to the capacitance and the applied voltage amplitude.

– **Residual-Current**

In the event of a fault, e.g. defective insulation, where an energized cable encounters an earthed person, an additional current flow which is referred to as residual current.

All inverters are equipped with a certified internal **residual current device (RCD)**, which protects against a possible electric shock in the event of a malfunction of the PV generator, the cables, or the inverter (DC). The residual current device in the NGEN inverters can detect faults on the DC side. According to the DIN VDE 0126-1-1 standard, two levels of protection are provided. The low protection level (30mA) is intended to protect against rapid changes in differential currents, usually in case of direct contact with a person. The high protection level (300mA) is intended to limit currents in grounding conductors for slow changes in differential currents.

In some countries, an external RCD circuit breaker is required. The installer must check which type of RCD the local grid operators require according to the local regulations and standards. NGEN recommends the use of a type A RCD circuit breaker with a value between 100mA and 300mA unless local regulations stipulate a lower value. Installations where the local electrical regulations require an RCD circuit breaker with a lower limit value may cause the external RCD Circuit breaker to trip unintentionally due to the discharge current. The following steps are recommended to prevent unwanted tripping of the external RCD:

1. The selection of a suitable RCD circuit breaker is important for the correct operation of the system. An RCD circuit breaker with a protective level of 30mA can be triggered even at a differential current of 15mA. High-quality circuit breakers, such as those from Schrack or EATON, generally trip at a value closer to their rated value.
2. Configure the tripping current of the RCD circuit breaker on the inverter side to a lower value than the tripping current of the external RCD circuit breaker. The internal RCD circuit breaker trips if the current exceeds the permissible value. However, as the inverters internal RCD circuit breaker resets automatically when the residual currents are low, there is no need to reset the RCD circuit breaker manually.

2.3. Surge Protection Devices (SPDs) for photovoltaic installations

	<p>Warning!</p> <p>-The grid-connected inverter is not equipped with surge protection devices (SPDs) on either the PV input side or the grid side. Lightning can cause damage to the photovoltaic system through direct strikes or through surges resulting from nearby strikes.</p> <p>-Induced surges are the most likely cause of lightning damage in most installations, especially in rural areas where electricity is usually provided by long overhead lines. These surges can affect both the PV string lines and the AC cables leading to the building. Therefore, consultation with lightning protection specialists should be sought. By using appropriate external lightning protection measures, the impact of a direct lightning strike on a building can be mitigated in a controlled manner, and the lightning current can be safely discharged into the ground.</p> <p>-Please select the appropriate surge protection devices (SPDs) according to local regulations and standards.</p>
---	--

3. Introduction

3.1. Basic Features

NGEN STAR-H1 series are high-quality inverters capable of converting solar energy into alternating current or storing it in a battery. The inverter can be utilized to optimize self-consumption, store energy in a battery for future use, or feed energy into a local or public grid. The operational mode depends on the PV energy and the preset system settings.

Advantages of the System:

- Advanced DSP control technology
- Uses the latest high-efficiency power components
- Advanced Anti-Islanding Solutions
- IP65 protection class
- Max. efficiency up to 97.08 %. EU efficiency up to 96.33%. THD<3%
- Safety & Reliability: Transformerless design with software and hardware protection.
- Export limitation (NGEN meter XY)
- Power factor regulation; user-friendly control panel
- LED status indicators
- LCD display for technical data, operating via four touch buttons
- Remote control via App or monitoring portal

3.2. System connection diagram

The description of the system (schematic representation) is generally shown in the following diagram. The system connection diagrams can be found in the attachment. (Page 53 - 55)

Schematic diagram:

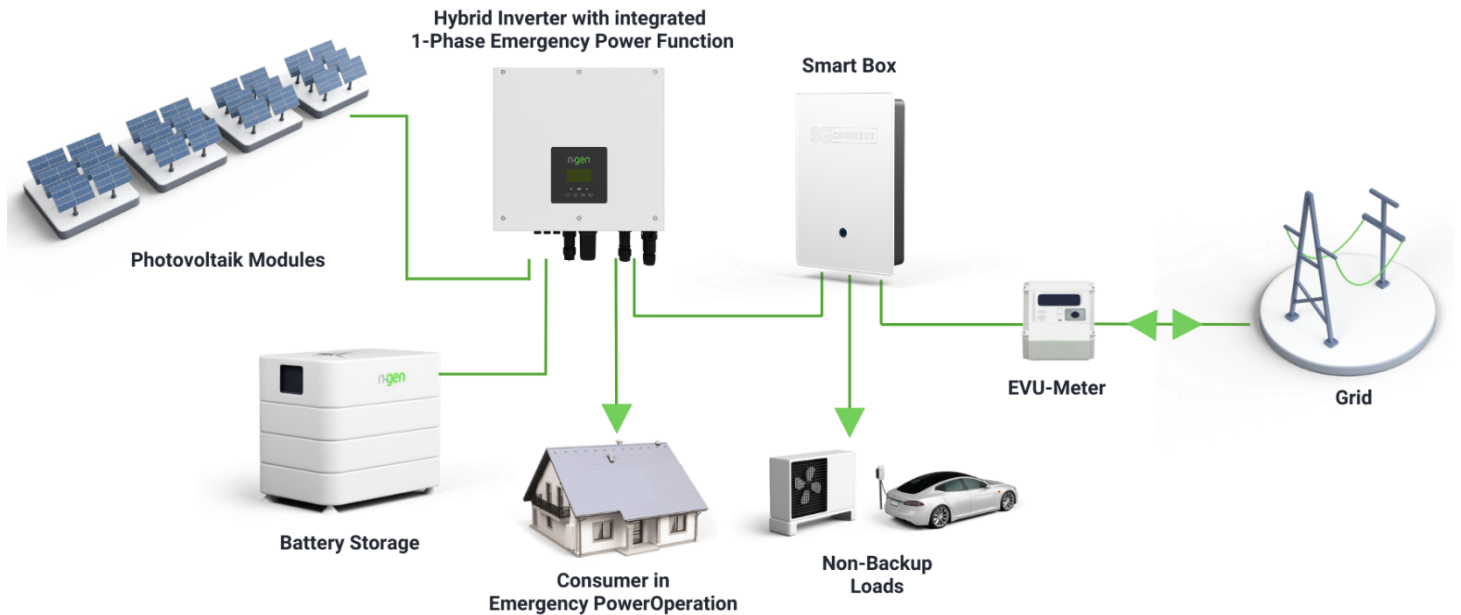

3.3. Working Modes

Work mode	Description
Self-Consumption (with PV power)	Priority: Loads > Battery > Grid The energy generated by the PV system is used to optimize self-consumption.
Self-Consumption (without PV power)	If no PV energy is produced, the battery first discharges for the local consumers and the grid supplies electricity if the battery capacity is insufficient.
Dynamic Prices	Priority: Loads > Grid > Battery In the case of self-consumption activation, energy from the storage system is used to supply local loads. In the case of dynamic pricing, the storage system is charged from the grid and the solar power plant only as much as allowed by the grid and the combined own production of the PV.
Back-up Power (PV + storage)	When the grid is disconnected, the system supplies emergency power from the PV system or the battery to supply the single-phase loads in the house (the battery is required in EPS mode).
Assistance to the Grid Operator + Phase Imbalance	The stored energy in the battery can also be used to regulate instability in the grid caused by excess energy produced by the solar power plant or an imbalanced phase load of consumers, thus ensuring grid frequency maintenance.
Peak Shaving	The system can be set to provide a peak shaving function. A Peak Shaving limit must be set by adjusting »Import limit« to the desired value. We can increase the peak shaving support uptime by setting the »Threshold SOC«. When the battery is above the »Threshold SOC« the system will work in »Self-Consumption« mode. When the battery is below the »Threshold SOC« the peak shaving function will be the priority and the system will only provide power from the battery when the »Import Limit« is exceeded. When below the »Threshold SOC« the system will charge from the grid when there is available power without exceeding the »Import limit«. This is to ensure prolonged Peak Shaving support for extended periods. If the »Import Limit« is exceeded constantly for an extended period of time, the peak shaving function can only guarantee successful operation while energy remains within the battery. If the battery designated »low level« is reached, the peak shaving function will cease.

Note: Charging time means that the battery is fully charged within the set time period. The charging time setting can be used in all models listed above. The charging period is mainly used to set the charging time from the power grid to the battery. The PV can also charge the battery when there is sufficient PV outside of charging time.

3.4. Dimensions

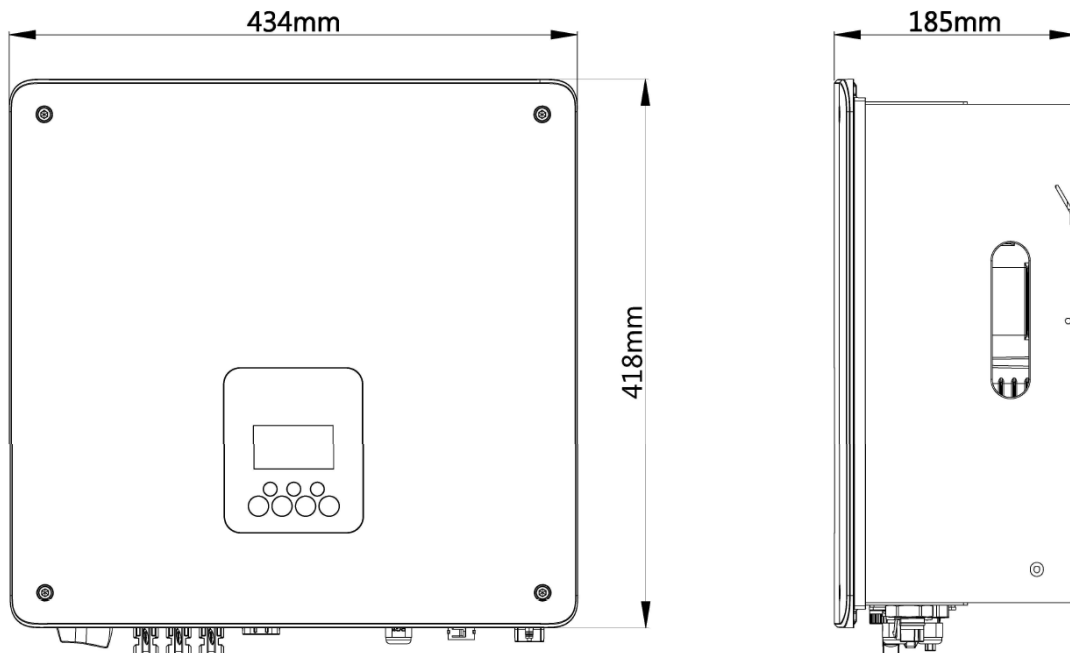

3.5. Inverter connections

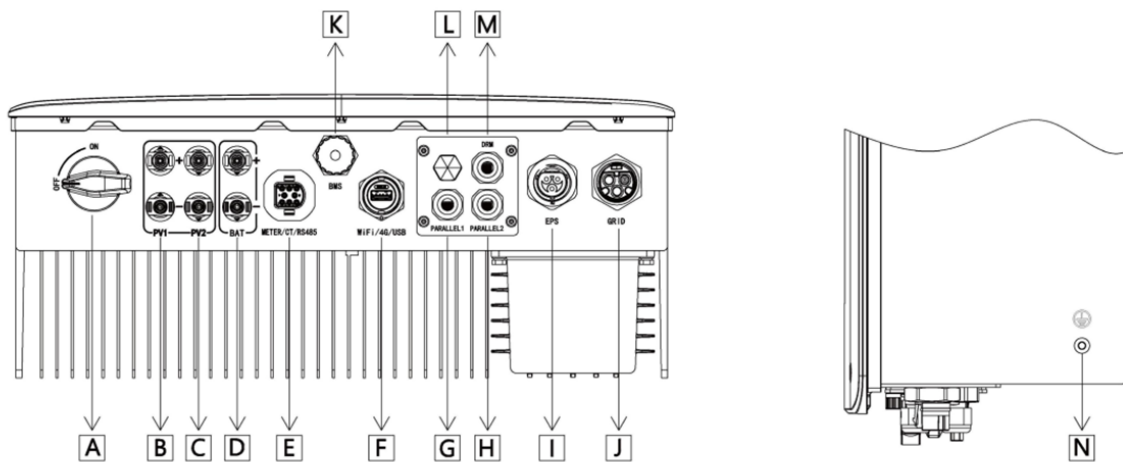

Pos.	Description	Pos.	Description
A	DC-Switch	I	EPS-Output
B	PV1	J	Grid-Connector
C	PV2	K	BMS
D	Battery-Connector	L	Waterproof lock valve
E	Meter / RS485	M	DRM
F	USB / WiFi / LAN	N	Grounding Screw
G	PARALLEL 1		
H	PARALLEL 2		

Note: The Connection may only be made by an authorized person!

4. Technical Specifications

4.1. PV-Input

Model	NGEN STAR-H1-3.7-E	NGEN STAR-H1-6.0-E
PV-INPUT		
Max. recommended DC-Power [W]	5500	9000
Max. Input Power per MPP Tracker [W]	2750 / 2750	4500 / 4500
Max. DC-Voltage [V]	600	
Nominal DC-Operating Voltage [V]	360	
Max. Input Current (INPUT A / INPUT B) [A]	16 / 16	
Max. Short-Circuit Current (INPUT A / INPUT B) [A]	20 / 20	
MPPT Volte Range [V]	80 - 550	
Start-up Input Voltage [V]	75	
Number of Independent MPP-Trackers	2	
Number of serial Strings per MPP-Tracker	1	

4.2. Battery-Input

Model	NGEN STAR-H1-3.7-E	NGEN STAR-H1-6.0-E
BATTERY-INPUT		
Battery Type	Lithium-Battery (LFP)	
Battery Voltage [V]	80 - 480	
Max. Charging/Discharging Current [A]	40	
Communication Interfaces	CAN/RS485	
Operating Temperature [°C]	-10 + 50	
Storage Temperature [°C]	-20 + 50	

4.3. AC-Output/-Input

Model	NGEN STAR-H1-3.7-E	NGEN STAR-H1-6.0-E
AC-OUTPUT		
Rated Output Power [VA]	3680	6000
Max. Output Apparent Power [VA]	4048	6600
Rated Grid Voltage (AC voltage range) [V]	220 / 230 / 240 (180 to 270)	
Rated Grid Frequency [Hz]	50 / 60	
Max. Output Current [A]	18.4	30
Power Factor	1 (Adjustable from 0.8 cap to 0.8 ind)	
Rated Output current [A]	16.7	27.3
THDI	<3%@ Rated Power	

AC-INPUT	NGEN STAR-H1-3.7-E	NGEN STAR-H1-6.0-E
Max. AC Input Power [VA]	7680	12000
Max. AC Input Current [A]	34.9	54.5

4.4. EPS-Output

Model	NGEN STAR-H1-3.7-E	NGEN STAR-H1-6.0-E
Max. Output Apparent Power [VA]	3680	6000
Peak Output Apparent Power [VA] (60s)	4400	7200
Rated Voltage [V]	220 / 230 / 240	
Rated Frequency [Hz]	50/60	
Max. Current [A]	16.7	27.3
Power Factor	1 (Adjustable from 0.8 cap to 0.8 ind)	
Parallel Operation	Yes @max. 10 Pcs	
Switch Time	<20ms	
THDI	<3%@ Rated Power	

4.5. Efficiency and Protection

Model	NGEN STAR-H1-3.7-E	NGEN STAR-H1-6.0-E
EFFICIENCY		
Max. Efficiency (PV to Battery)	98.50%	
Max. Efficiency	97.08%	
Euro-Efficiency	95.70%	96.33%
PROTECTION		
Isolation Monitoring	YES	
Residual Current Monitoring	YES	
DC Reverse Polarity Protection	YES	
Anti-Islanding Protection	YES	
AC Short-Circuit Protection	YES	
AC Output Overcurrent/Overvoltage Protection	YES	
DC - Switch	YES	
Battery Wake up Function	YES	
Overvoltage Protection (SPD)	DC: Typ II / AC: Typ III	
AFCI-Protection	Optional	

4.6. General Data

DIMENSIONS AND WEIGHT	
Dimensions (W x H x D) [mm]	434*418*185
Weight [kg]	22
Cooling	Natural Convection
Inverter Topologie	Non-Isolated
Communication Interface	Meter, WIFI, LAN (optional), 4G (optional), DRM, USB, CAN, RS485, Ripple Control
LCD-Display	Backlight 16*4 Character
ENVIRONMENTAL LIMIT	
Installation	Wall-mounted
Protection Degree	IP65
Operating Temperature Range [°C]	-25..... +60 (power derating at +45°C)
Storage/Operation relative humidity	0%-100% (without Condensation)
Max. Operating Altitude [m]	<2000
Protective Class	I
Storage-Temperature [°C]	-40..... +70
Standby-Consumption [W]	<10
Button	4x Capacitive touch sensor
Noise Emission [dB]	<35
CERTIFICATIONS	
Safety	EN 62109-1 ; EN 62109-2
EMC	EN 61000-6-2 ; EN 61000-6-3
Certificates	EN50549-1 ; C10/11 ; VDE-AR-N 4105 ; G98 ; G99 CEO 0-21 ; NRS 097-2-1 ; AS/NZS 4777.2

5. Installation

Before installing the device, make sure that the inverter has not been damaged during transport. If there are visible damages, such as cracks, please contact the product seller immediately.

5.1. Scope of delivery

Open the packaging and take out the product, please check the accessories first. The packaging list is shown below:



Inverter

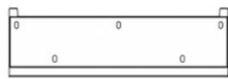

Mounting-Bracket

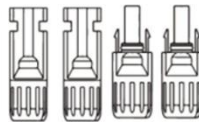

PV-Connectors



PV-Pin-Contacts



Screw anchors, Screws



AC-Connector



Grounding-Connection



Communication-Connector

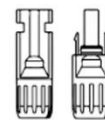

Battery-Connectors



Batterie-Pin-Contacts



Quick Guide



Smart Meter



WIFI-Dongle



RJ45-Connector

5.2. Mounting guidelines

Ensure that the installation location fulfils the following conditions:

- Not in direct sunlight
- Not in areas where highly flammable materials are stored
- Not in potentially explosive areas
- Not directly outdoors
- Not near a television antenna or antenna cable
- Not higher than approximately 2.000 meters above sea level
- Not in an environment with precipitation or high humidity (> 95%)
- Good ventilation conditions must be ensured:
 - The ambient temperature in the range of -25°C to + 60°C
- The Wall on which the inverter will be mounted must meet the following conditions:
 - A. Solid brick/concrete or other equivalent surface suitable for mounting
 - B. The inverter must be supported or additionally reinforced if the Wall is not strong enough (e.g. wooden wall, wall covered with a thick layer of decoration).
 - C. The inclination of the Wall should be within +5°

- Please avoid direct sunlight, rain and snow during installation and operation:

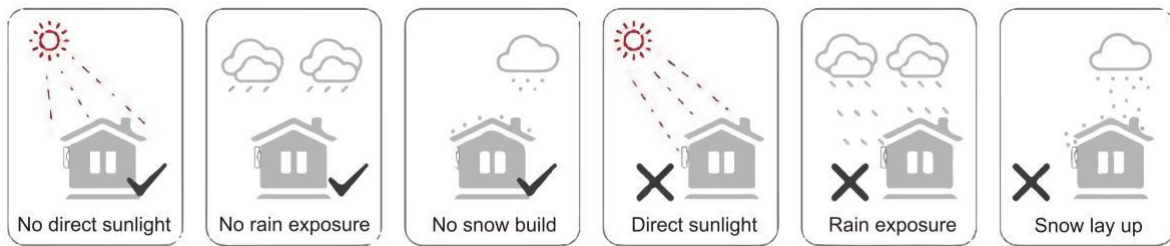

- Note the minimum distance to adjacent objects on the wall:

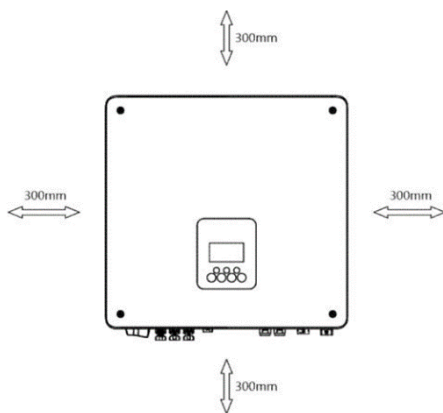

Position	Minimum distance
Left	300mm
Right	300mm
Top	300mm
Bottom	300mm

5.3. Required tools

The following tools are required to install the inverter:

- Screwdriver (M5, M6)
- Electric drill (with 8mm drill bit set)
- Crimping pliers
- Insulation stripping pliers
- Manual wrench



5.4. Assembly steps

Step 1: Attach the inverter bracket to the wall

- Select the location where you want to install the inverter. Attach the mounting bracket to the wall and mark the position for the 5 holes of the bracket:

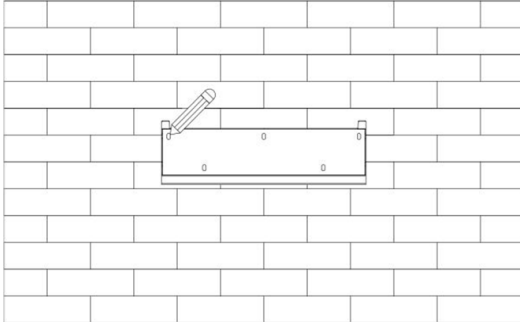

Danger!

Before drilling, make sure that the water and electricity lines in the wall are not damaged at the installation site of the wall bracket to avoid hazards.

- Drill the holes with an electric drill and make sure that the holes are at least 50mm deep and 8mm wide. Then fit the supplied dowels in the pre-drilled holes.

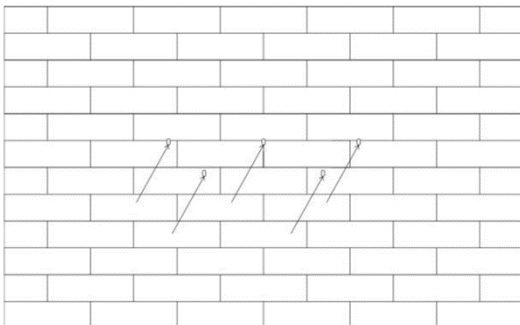

- Fit the mounting plate to the holes already prepared using the fixing screws supplied.

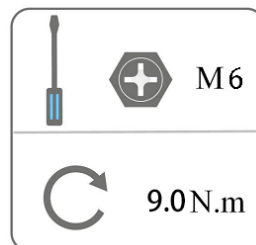
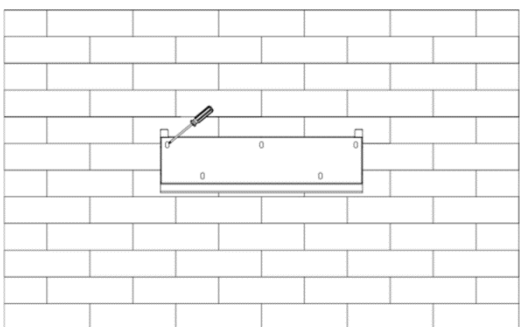

Step 2: Hang the inverter on the wall bracket

- Mount the inverter on the bracket. Secure the inverter with the supplied M5 screws and washers.

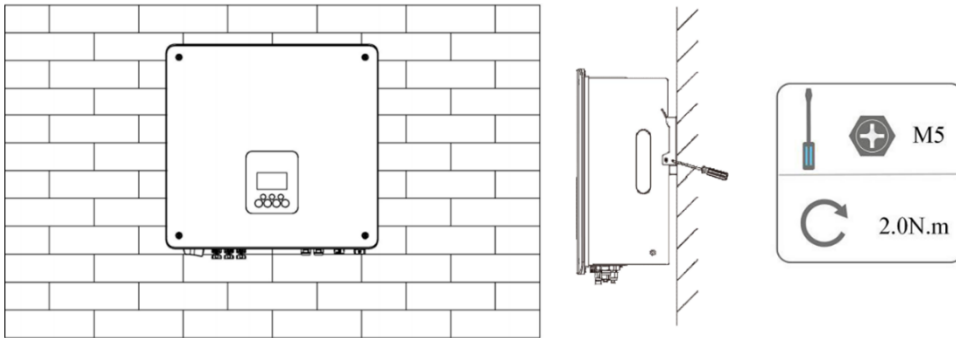

6. Electrical Connection

6.1. Connection of the PV strings

The STAR-H1 series inverter have two MPP-Trackers. Only one serial String is allowed per input! On-site parallel connection of the PV strings is not permitted:

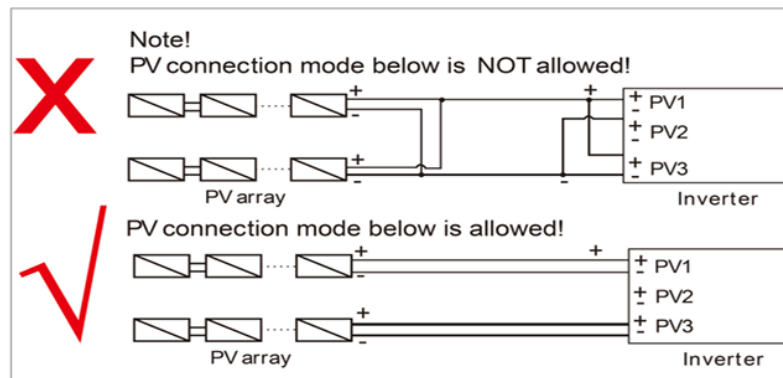

The open-circuit voltage of the connected string of modules must be less than 600V and the operating voltage must be within the MPP-Tracker voltage range. Also observe all other inverter limitations (see datasheet).

	<p>Warning! The voltage of the PV modules is very high and within a dangerous voltage range. Please follow the electrical safety rules when connecting it.</p>
	<p>Warning! Please do not connect PV positively or negatively to the ground.</p>
	<p>Note! PV-Modules: Please ensure that they are from the same manufacturer, have the same output and specifications, are equally aligned and titled at the same angle. To save cables and reduce DC power losses, we recommend installing the inverter as close as possible to the PV modules.</p>

Step 1: Fitting the DC (PV) plug

The DC plugs included in the scope of delivery are designed for a cable cross-section of 2.5 mm² to 6.0 mm².

- Cut off 6mm of the insulation from the end of the wire:

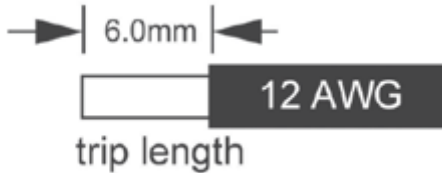

- Separate the DC (PV) connector as shown below:

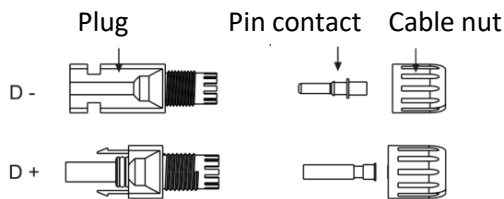

- Insert the stripped cable into the pin contact and make sure that all conductor wires are included in the contact slot. Then insert the pin contact into the crimping pliers and crimp the contact.

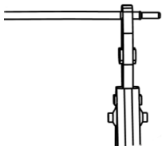

- Insert the pin contact through the cable nut and mount it on the backside of the male or female connector. If you feel or hear a „Click“, the pin contact is correctly installed.



Step 2: Connecting the DC cable (incl. Plug) to the inverter

- Switch of the DC switch
- Connect the mounted plugs to the pre-mounted plug on the inverter. Ensure that the strings are correctly distributed on the MPP trackers.
- To unlock the DC plugs, follow the steps below:

	<p>Danger! Before disconnecting the DC plug, make sure that there is no current at the DC plug. You must measure this with a current clamp meter or deactivate the DC switch, otherwise serious safety accidents may occur.</p>
--	--

- Use a suitable key.
- When disconnecting the DC+ plug, press the tool from top to bottom.
- When disconnecting the DC- plug, press the tool from bottom to top.
- Disconnect the plugs by hand.

6.2. Connecting the Battery

	<p>Note! The battery cables as well as the right communication cable for the connection between the battery and the inverter are prefabricated and included in the battery package. To make your own connection cables between the battery and the inverter, follow the steps below:</p>
---	---

Step 1: Fitting the Battery Plug

The Battery plugs included in the scope of delivery are designed for a cable cross-section of 6 mm².

- Cut off 6mm of the insulation from the end of the wire:

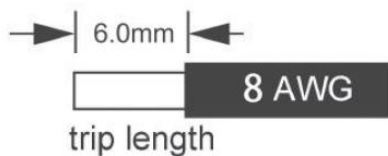

- Separate the DC (PV) connector as shown below:

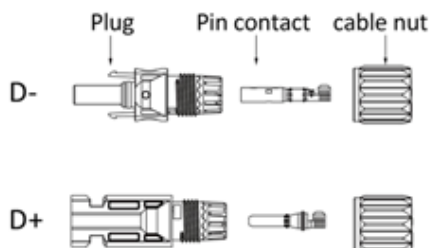

- Insert the stripped cable into the pin contact and make sure that all conductor wires are included in the contact slot. Then insert the pin contact into the crimping pliers and crimp the contact.

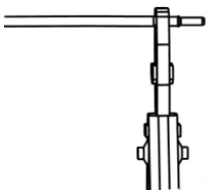

- Insert the pin contact through the cable nut and mount it on the backside of the male or female connector. If you feel or hear a „Click“, the pin contact is correctly installed.

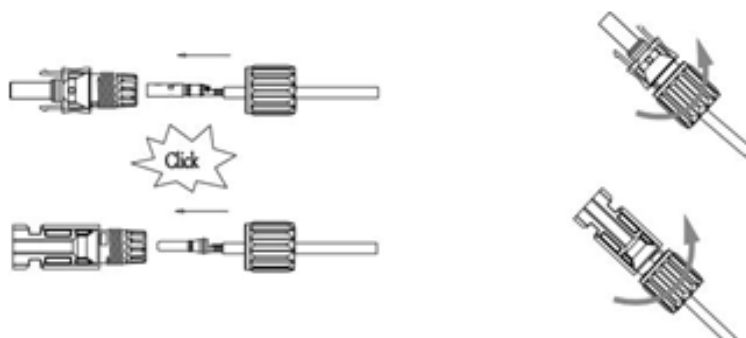

Step 2: Connecting the Battery cable (incl. Plug) and the Communication cable to the inverter

- Switch of the DC switch on the Battery and the Inverter
- Connect the mounted plugs to the pre-mounted plug on the inverter. Ensure that the batteries are connected to the correct connection on the inverter.
- To unlock the DC plugs, follow the steps below:

	<p>Danger! Before disconnecting the Battery connector, make sure that there is no current on the Battery connector. You must measure this with a current clamp meter or deactivate the Battery switch, otherwise serious safety accidents may occur.</p>
---	---

- Use a suitable key.
- When disconnecting the Battery + plug, press the tool from top to bottom.
- When disconnecting the Battery - plug, press the tool from bottom to top.
- Disconnect the plugs by hand.

6.3. AC-Connection to the Grid

The NGEN STAR-H1 series inverters are designed for single-phase grid connections. The voltage range is 220/230/240V, the frequency is 50/60Hz. Other technical requirements must comply with the requirements of the local public grid.

 No consumers should be connected between the circuit breaker of the inverter and the inverter itself.



	<p>Warning! A circuit breaker must be installed between the inverter and the grid as a protective device for the maximum output overcurrent protection.</p>
---	--

Before you start installing the AC-Plug, disconnect the circuit breaker from all phases and secure it against reconnection!

Step 1: Stripping the AC-Cable

- Shorten the L1/L2/L3 and N wires to 52.5 mm and the PE wire to 55 mm.
- Use the stripping pliers to cut 12 mm of the insulation from all wire ends as shown below:

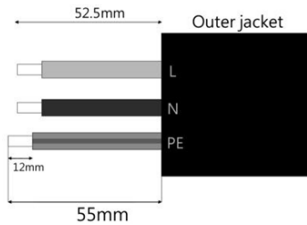

L1: Brown/Red wire
N: Blue/Black wire
PE: Yellow & Green wire

Attention!
The permitted cable cross-section is:
5 x 6 mm².



Note!
Please note the local cable type and colours for the actual installation. The wiring of the power grid must be connected to the N line, otherwise the inverter will report an error and cannot work normally. The SW BUS Volt fault will appear.
Before connecting the inverter to the AC-Grid, check the grid voltage and compare it with the permissible voltage range (see technical data).

Step 2: Fitting the AC-Plug

- Separate the AC plug into three parts as shown below. To do this, Hold the middle part of the connector and remove the upper part of the connector. Remove the nut together with the sealing element

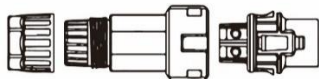

- First push the cable through the nut, sealing element, and the middle part of the connector. Insert the wires into the plug and tighten them with a suitable screwdriver. Pay attention to the correct positions (L1/N/PE)

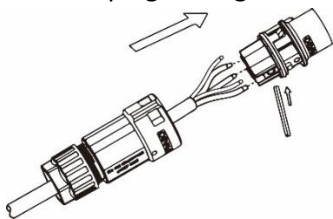

- Press the threaded sleeve into the socket and tighten the nut.

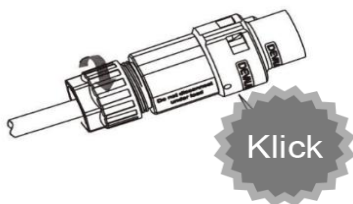

Step 3: Connecting the AC-Plug to the Inverter

- Connect the connector to the inverter and lock it.

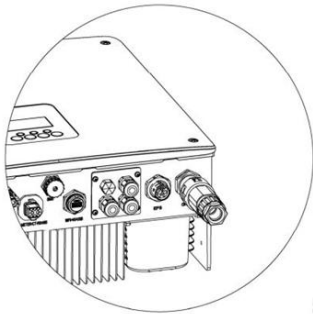



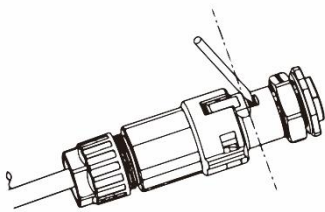





- To disconnect the AC plug from the inverter, release the lock with a screwdriver (see following image):



6.4. Connecting the loads to the EPS output

In the event of a grid failure, the inverter's emergency power function disconnects the inverter from the grid and supplies all loads connected to the EPS output (EPS = Emergency Power Supply). The emergency power supply function is single-phase and already integrated in the inverter.

If you want to connect an inductive load to the EPS, please make sure that the starting power of these consumers is lower than the maximum power of the EPS output (1x 16.7A for the 3.7kW H1-Inverter and 1x 27.3A for the 6kW H1-Inverter). The table below shows the most common consumers and their starting and operating powers. Please refer to the manual of your devices for the actual technical data.

Type	Power		Common equipment	Example		
	Start	Rated Power		Equipment	Start	Rated Power
Resistive Load	X1	X1	  Incandescent lamp TV	 100W Incandescent lamp	100VA (W)	100VA (W)
Capacitive Load	X2	X1,5	 Fluorescent lamp	 40W Fluorescent lamp	80VA (W)	60VA (W)
Inductive Load	X3~5	X2	  Fan Fridge	 150W Fridge	450-750VA (W)	300VA (W)

Note: Unipolar loads are not supported

Step 1: Select explicit consumers

For the emergency power function, select explicit loads that do not exceed the maximum power of the inverter in EPS mode. Pay particular attention to the maximum permissible current and voltage values (see data sheet). The wiring for emergency power operation can be found in the appendix!

Step 2: Fitting the EPS-Plug

- Shorten the L1 and N wires to 52,5 mm and the PE conductor to 55 mm.
- Use the stripping pliers to cut 12 mm of the insulation from all wire ends.
- Disassemble the plug and slide the parts onto the cable:

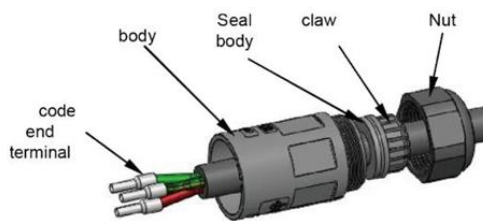

Attention!
The permissible cable cross-section is **3 x 6 mm²**.

- Insert the wires into the plug and tighten them with a suitable screwdriver (screw torque 0.8 Nm +/- 0.1 Nm). Pay attention to the correct positions (L1/N/PE).

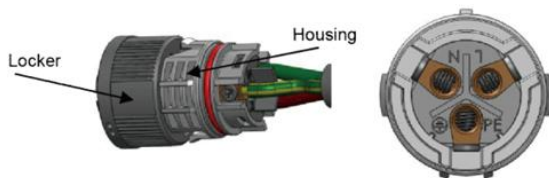

- Bring the plug parts together until you hear a click.

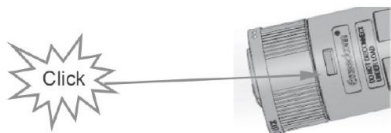

- Push the sealing ring to the end of the housing and tighten it with the nut. The torque should be (2.5 Nm +/- 0.5 Nm).

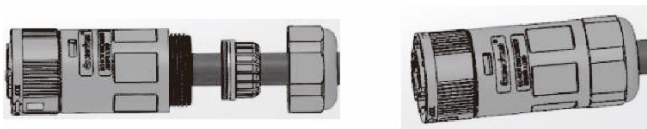

- Plug the fully assembled EPS connector into the inverter. Please observe the LOCK marking on the module for the direction of rotation of the locking mechanism.

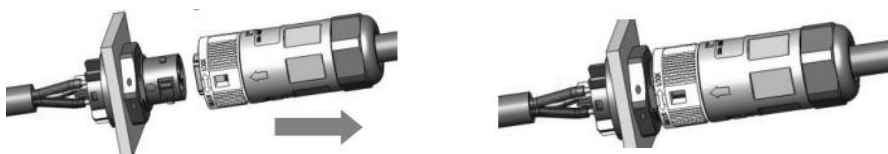

- To remove the EPS connector, release the lock with a screwdriver. Turn the sleeve in the direction of the UNLOCK marking on the assembly and then pull out the plug.

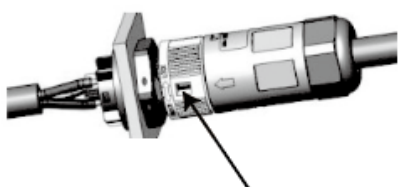

6.5. Connecting the inverter to an earthing system

- Use a 16mm² earthing cable for earthing
- Strip off 6 mm of the insulation from the end of the cable.

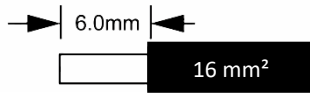

- Insert the stripped cable into the grounding connector and make sure all wires strands are inside the connector. Crimp the earthing connection using crimping pliers.

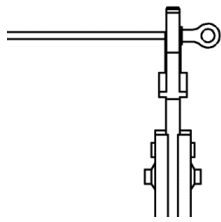

- Tighten the earthing screw with a screwdriver as shown below.

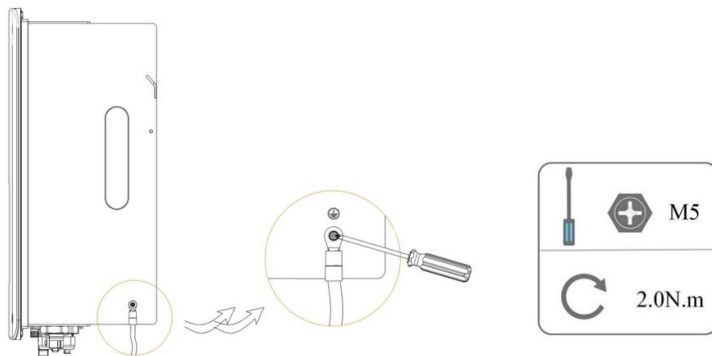

6.6. Integration of other generating devices in emergency power operation

The connection and use of a generator is prohibited if the generator is part of the same circuit as the inverter. The permitted use is shown in the figure below:

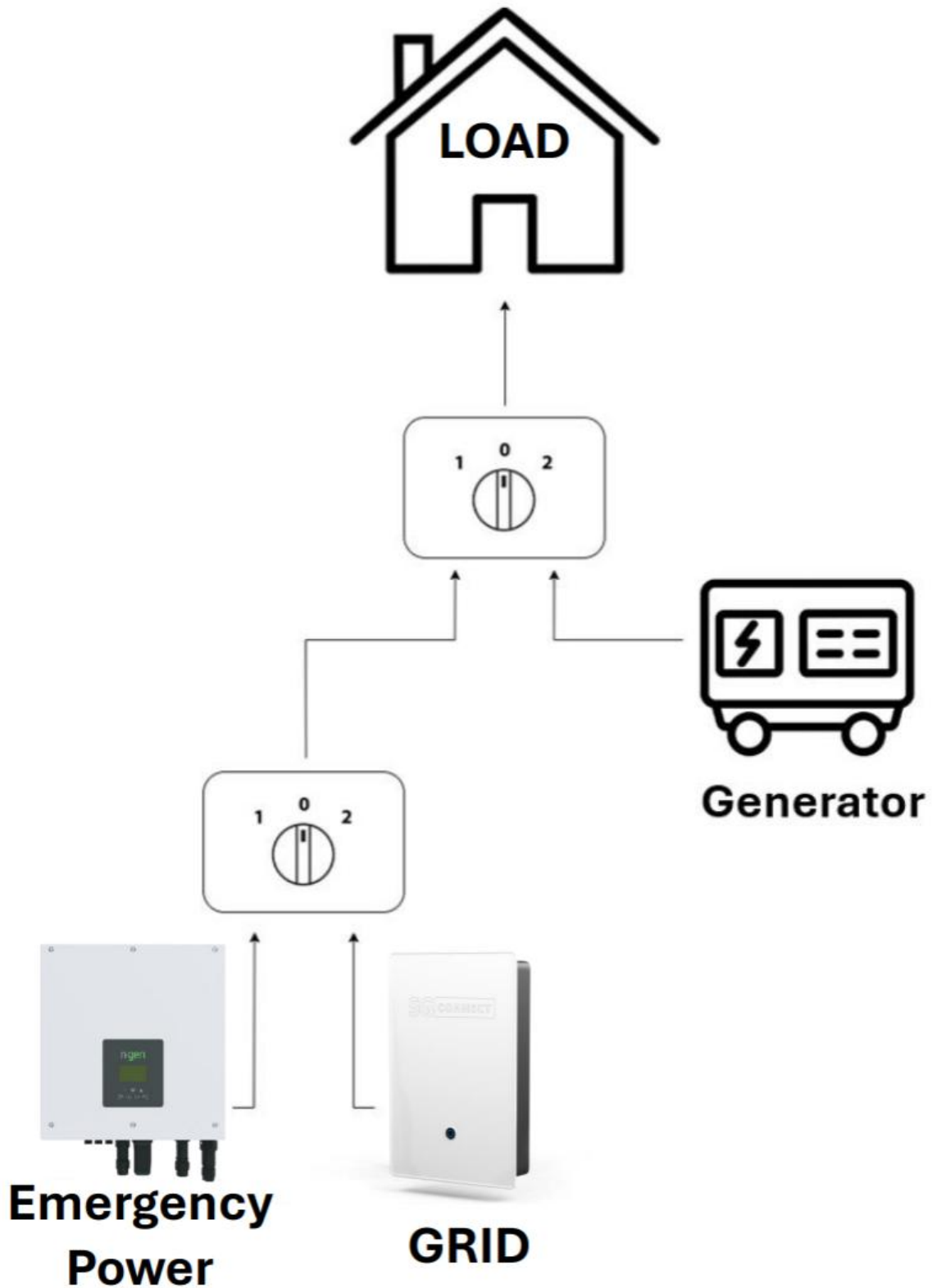

6.7. Connection WIFI/LAN/4G-Dongle



The inverter has an interface for WIFI/LAN/4G, which enables the device to collect information from the inverter. Operational information's such as voltage, current, frequency, error messages, etc., can be monitored locally or remotely through these interfaces. A LAN dongle is included as standard with the NGEN Star inverter. If necessary, you can order the WIFI / 4G dongle from your local supplier.

Steps for connection:

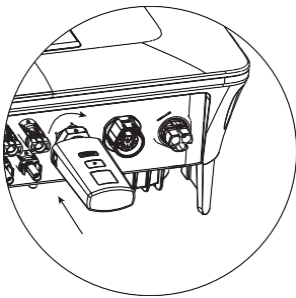
1. For 4G-Devices: Please insert a SIM card (for more details, refer to the 4G installation manual). **(Optional)**
2. Plug the WIFI/LAN/4G device into the USB-Port on the bottom of the inverter.



3. For WIFI-Devices: Connect the WIFI dongle to the local router and complete the WIFI configuration (for more details, refer to the WIFI installation manual). **(Optional)**
4. For LAN-Devices: Connect the LAN dongle to the local internet router using an Ethernet cable.

	<p>Note! If you are using the Smart Box from NGEN, you can connect the LAN dongle directly to the switch inside the Smart Box using an Ethernet cable.</p>
	<p>Note! The Dongle must always remain connected to the Internet. This is essential to enable remote control and to perform remote firmware upgrades of the device.</p>

6.8. Inverter Communication Connection

For proper installation of the communication connection, please refer to the pin definition of the communication plug provided below:

- Note the pin definition of the communication plug:



PIN	1	2	3	4	5	6	7	8
Definition	Meter 485A	Meter 485B	485B	485A	CT2+	CT2-	CT1-	CT1+

	Note! If the inverter is used in combination with the Smart Box from NGEN, pins 5 to 8 are not required.
	Note! Recommended cable for the communication connection: LIYCY 4x2x0,5mm2

6.8.1. Communication Connection using the Smart Box

When using the NGEN-Star Hybrid Inverter in combination with the Smart Box, please use the pre-prepared cable included in the scope of delivery for the communication connection between the inverter and the Smart Box. Refer to the connection diagram below:

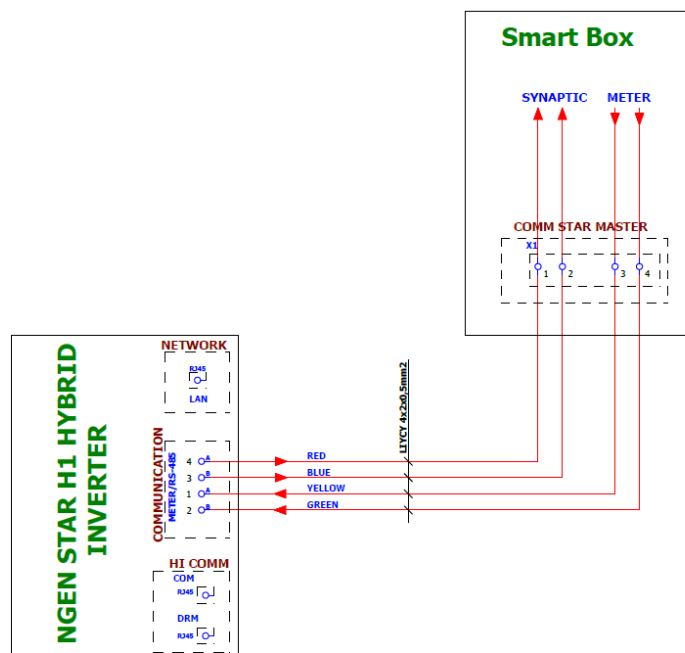

6.8.2. Communication Connection without Smart Box only with Synaptic and Smart Meter

If you are using the NGEN-Star System without the Smart Box, but in combination with the communication devices (Synaptic and Smart Meter) please refer to the following connection diagram:

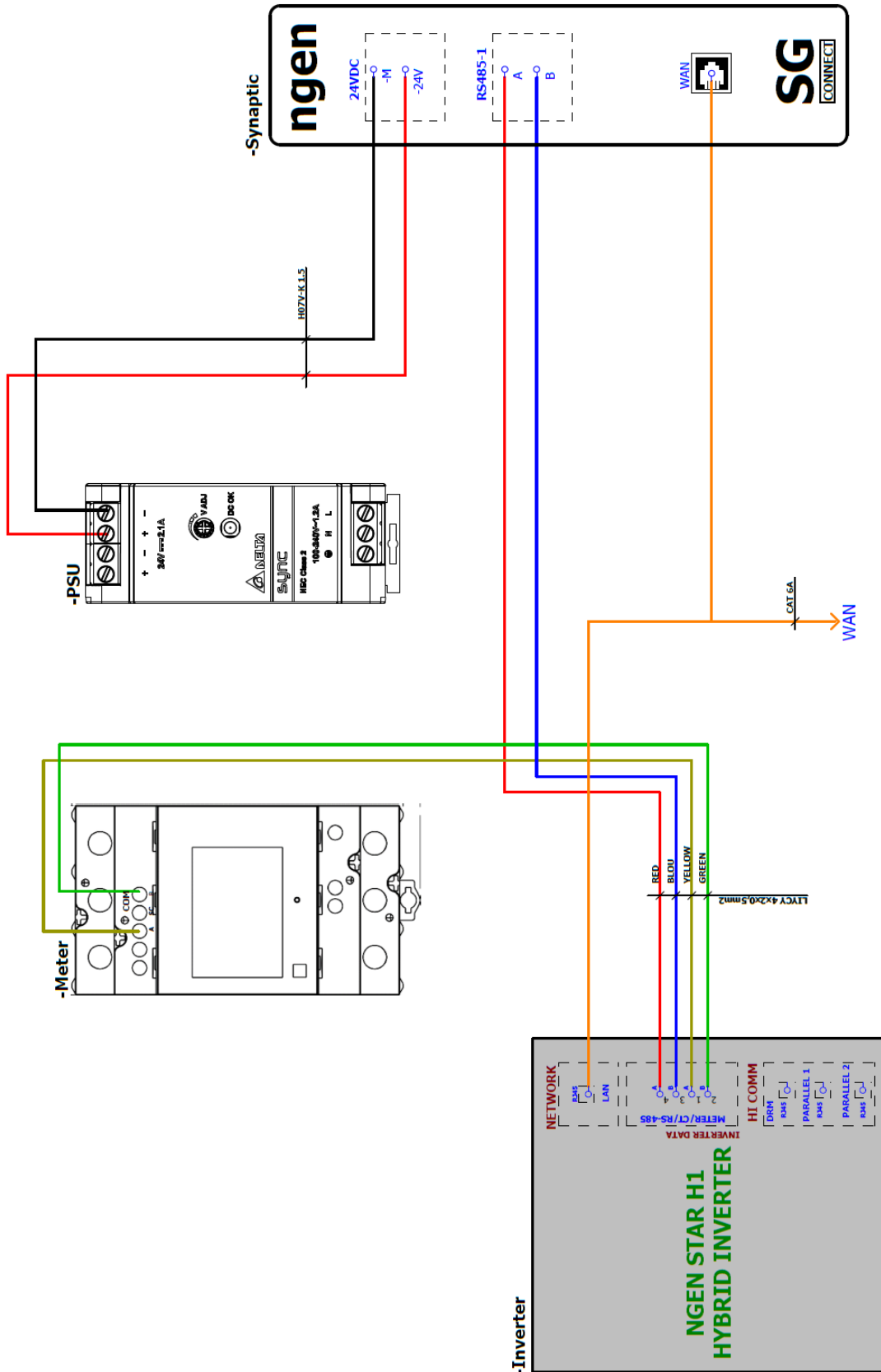

6.9. Configuration of the used measuring device (Smart Meter / CT) in the inverter menu

To ensure accurate measurements and that the inverter correctly detects the connected load, follow the steps below to properly configure the inverter. This setup will enable the inverter to identify whether it is connected to a direct single-phase meter, a direct three-phase meter, or a meter with Current Transformers (CT).

Steps for configuration:

- First, access the inverter menu by pressing the „✓“ button, then navigate to the inverter settings using the default Password “0000”.
- In the inverter settings, go to the „Feature“ menu and open the „Meter/CT“ submenu.
- Select the appropriate configuration for the „Meter/CT“ submenu based on the installation. Choose between the following options
 - Meter_1P (Direct single phase Smart Meter) – **Standard from NGEN inside the Smart Box**
 - Meter_3P (Direct three phase Smart Meter)
 - CT (Smart Meter with current clamps)

6.10. Combination of NGEN-STAR inverters with an existing generation system

NGEN supports the function of the second electricity meter, which is used to measure the power generation of other power generation system (existing inverters) and to summarize the monitoring data in the NGEN monitoring Platform.

NGEN only provides one Smart Meter in the scope of delivery, which communicates with the inverter and measures the house consumption at the house node. The Smart Meter is already pre-programmed with all the necessary data (address: 1, baud rate: 9600).

However, if there is a second inverter due to an existing photovoltaic system, it can be installed a second Smart Meter to measure the output of the existing generation unit and integrate it into the monitoring interface. For the second Smart Meter the following settings are required (address:2, baud rate: 9600).

If the settings mentioned above are not executed correctly, errors may occur in the measurement data and be reflected in the monitoring Interface.

Below you will find the wiring diagrams for different use cases to integrate an existing PV generation system!

6.10.1. Wiring diagram using the Smart Box

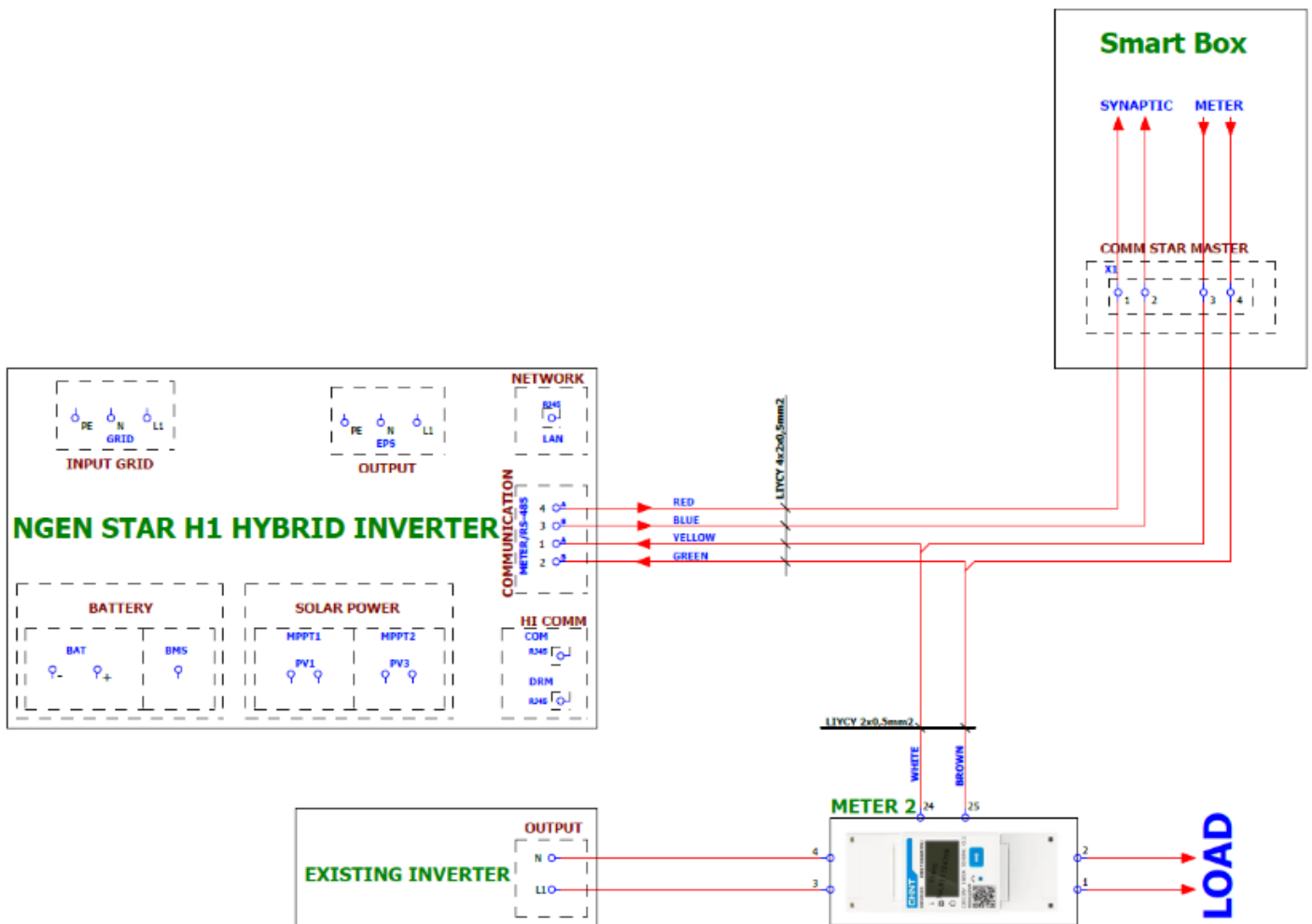

6.10.2. Wiring diagram without Smart Box only with Synaptic and Smart Meter

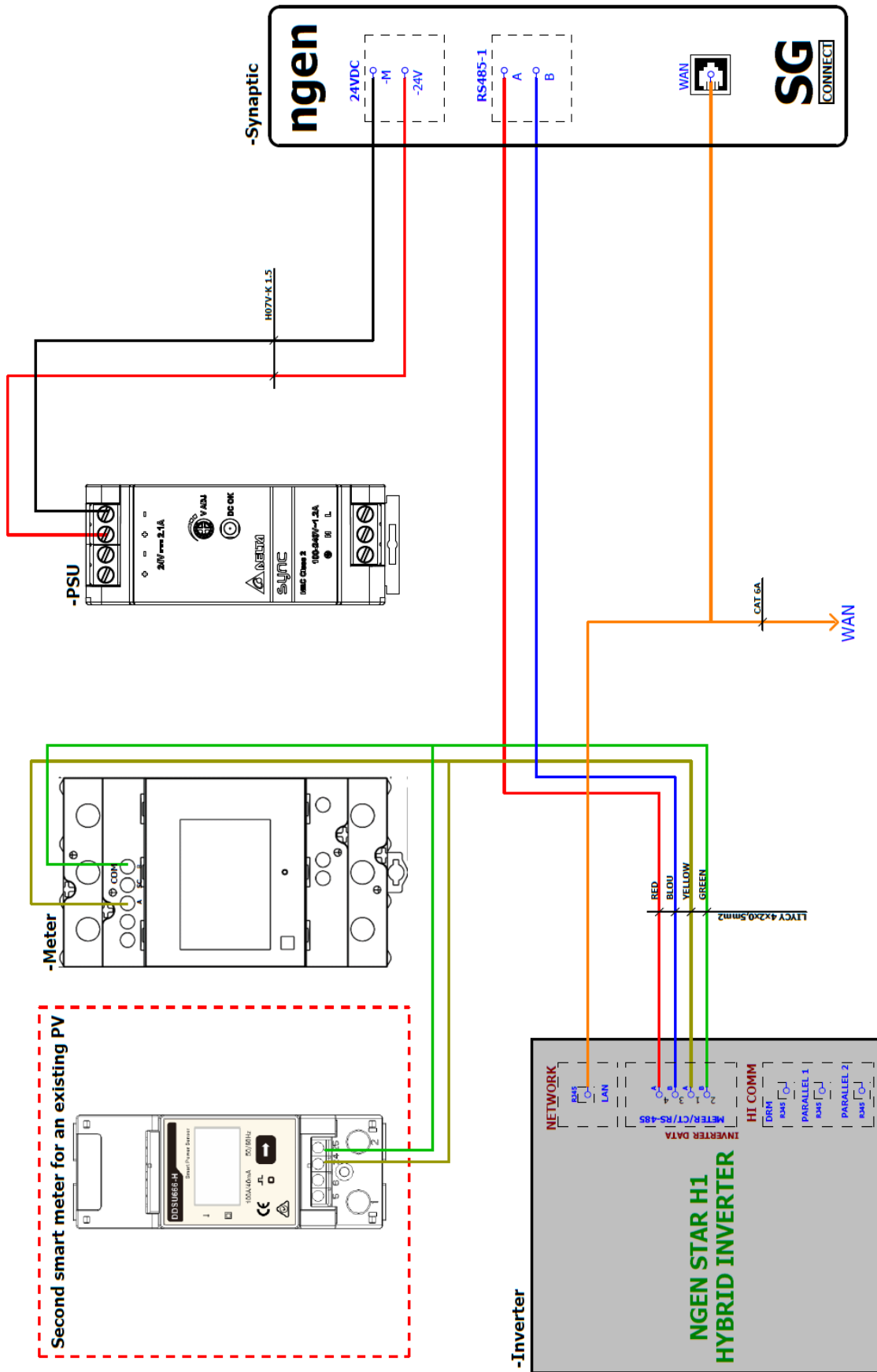

6.11. Set up of the second Smart Meter

To be able to use the functions of the second smart meter, the following settings are required!

Settings on the inverter:

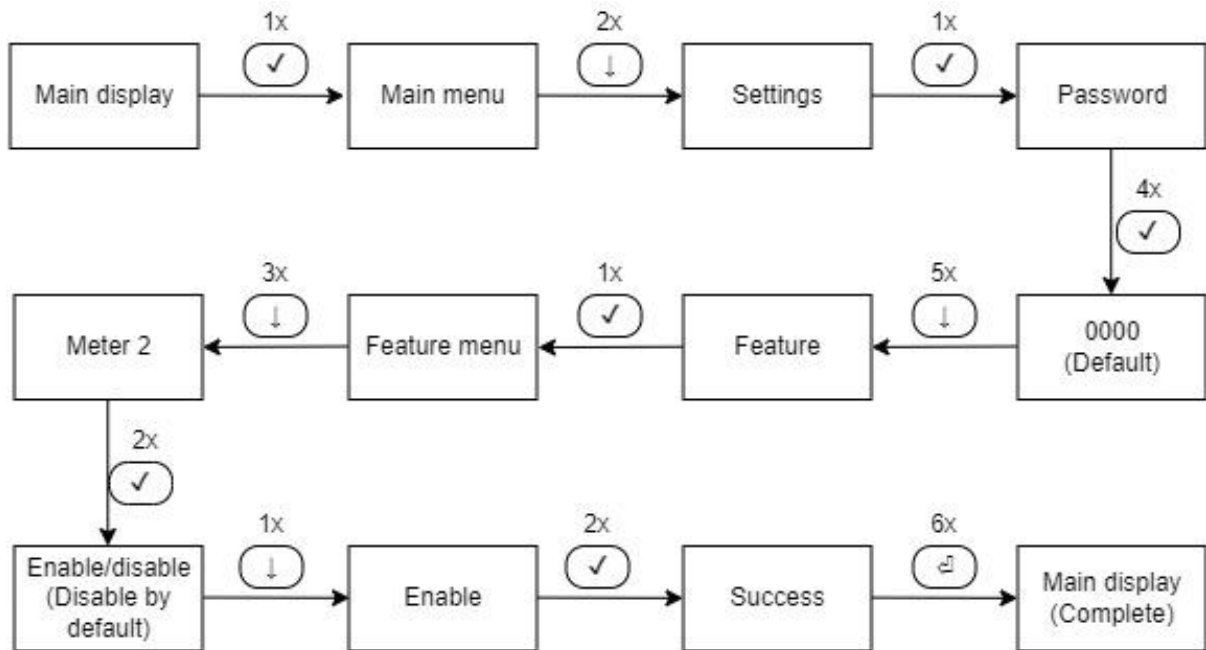

Settings on the second Smart Meter:

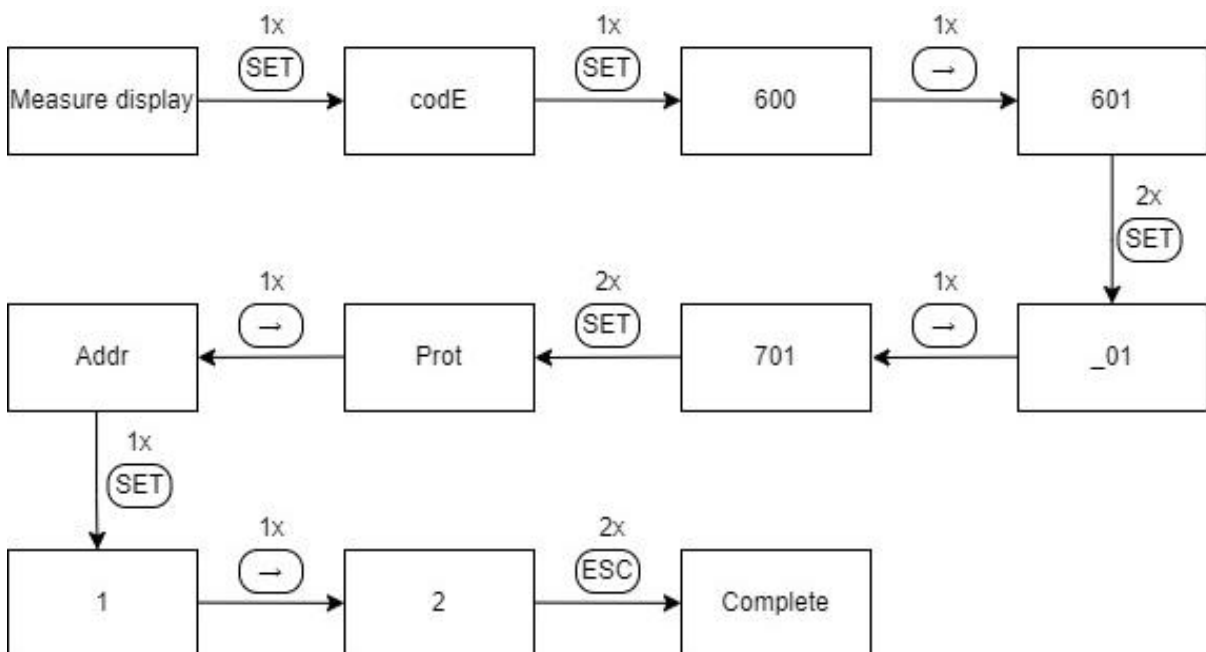

6.12. DRM/E-Stop-Interface

The NGEN-STAR inverter has a DRM function (DRM = Demand Response Mode). This function ensures that the inverter always implements the commands for active power limitation from the grid operator. In some countries, the installation of a DRM interface is not required. However, this function may be required by law in other countries. Therefore, please observe the local regulations before installing the inverter.

- Settings path:



- The DRM supports multiple response modes to demand by transmitting control signals, as shown below:

Mode	Requirement
DRM0	Stop the operation of the inverter.
DRM1	Do not consume power.
DRM2	Do not consume more than 50% of rated power.
DRM3	Do not consume more than 75% of rated power
DRM4	Increase power consumption.
DRM5	Do not produce power.
DRM6	Do not produce more than 50% of rated power.
DRM7	Generation is not more than 75% of the rated power and purchase of reactive power, if possible
DRM8	Increase power generation.

Note: Currently only the DRM0 function is supported, other functions are under development.

- DRM PIN Definition (Connection Point „DRM“ on the inverter)

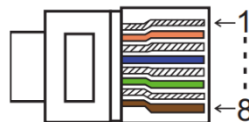

PIN	1	2	3	4	5	6	7	8
Definition	GND_COM	Shutdown	OUT_DRM0	3.3V_COM	OUT_DRM 4/8	OUT_DRM 3/7	OUT_DRM 2/6	OUT_DRM 1/5
MODEL	CONNECTOR SHOWN BY PINS			FUNCTION				
DRM0	3		4	Operate with disconnecting device				

- E-STOP PIN Definition (Connection Point „DRM“ on the Inverter)

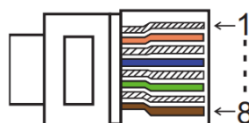

MODEL	CONNECTOR SHOWN BY PINS		FUNCTION
E-STOP	1	2	Emergency stop of the inverter

6.12.1. Connection Diagram for the E-Stop Function using the Smart Box

If you want to use the E-Stop function of the inverter in combination with the Smart Box, please refer to the following connection diagram:

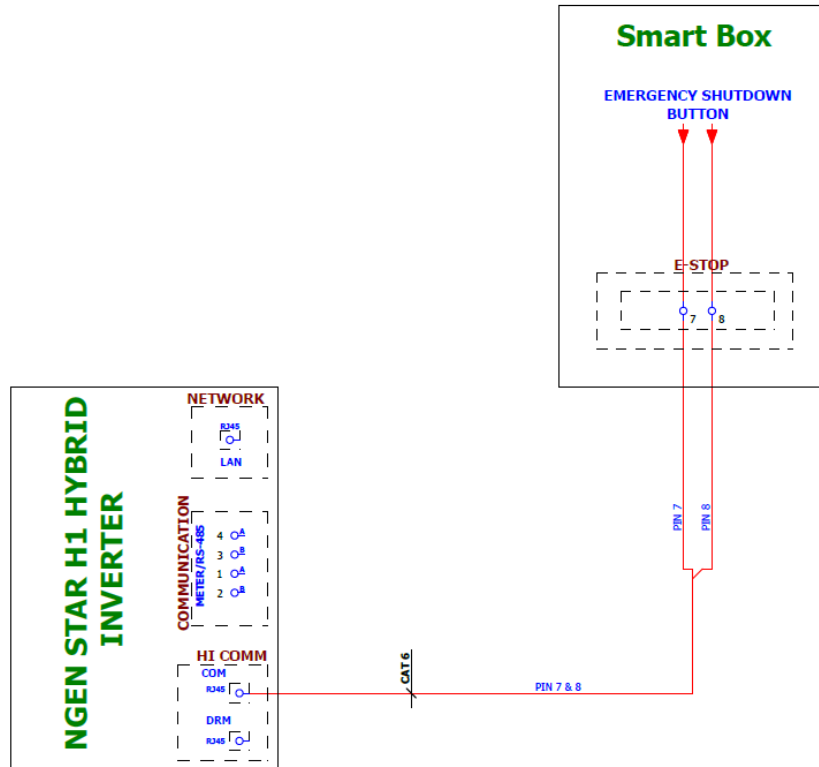

6.13. Inverter Start-up

Please follow the steps below for commissioning the inverter:

1. Ensure that the inverter is securely fastened.
2. Ensure that all DC and AC wiring is connected properly.
3. Ensure that the communication connection is properly connected.
4. Ensure that the battery is properly connected.
5. Make sure that the external EPS contactor is properly connected (if necessary)
6. Make sure that the BMS buttons and the battery switches are switched off.
7. Turn on the PV / DC switch, the AC breaker, the EPS breaker and the circuit breaker on the battery.
8. Open the setting page; the default password is „0000“, select START / STOP and set it to Start. (Long press „Enter“ to quickly enter the START / STOP page).



Note!

To avoid communication issues, it is essential to ensure that the inverter is fully started up before powering on the battery. For instructions on starting the battery, please refer to the corresponding Battery Installation Manual.

 Please note:

- When you start the inverter for the first time, the country code is set to the local settings by default. If you want to change the country code, please follow these menu steps: Settings -> On-Grid -> Safety



- Set the local time in the inverter settings menu. Settings -> Date & Time

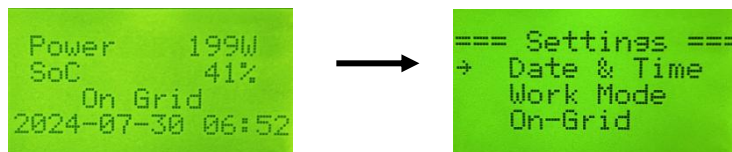

- The internal bypass relay is closed by default, if it needs to be opened, enter the setting page and select “Internal”.
- The EPS function is disabled by default. If the EPS function is needed, activate it in the settings (Settings -> Off-Grid -> EPS Output). The standard EPS voltage and frequency are 230V and 50Hz

6.14. Software Upgrade

The user can update the inverter firmware via a USB-Drive.

Safety check

- Please ensure that the inverter is always switched on.
- The inverter must remain switched on during the entire update process. Please prepare a personal Computer and make sure that size of the USB-Drive is less than 32 GB, and the format is FAT16 or FAT32.

	<p>Attention! Please do NOT connect a USB 3.0 to the USB port of the inverter. The USB port of the inverter only supports USB 2.0.</p>
---	---

Steps for updating:

- Step 1: Please contact our service department and obtain the update files, which you should load onto a USB-Disk as follows:

update/manager/ H1_Manager_Vx_xx_E.bin

update/master/H1_E_Master_Vx.xx.bin

update/slave/ H1_E_Slave_Vx.xx.bin

Note: Vx.xx is the version number.

Warning: Make sure that the directory of the USB stick matches the above specifications! Do not change the name of the program file, as this may cause the inverter to malfunction.

- Step 2: Unscrew the waterproof cover and insert the USB-Drive into the USB port on the bottom of the inverter.

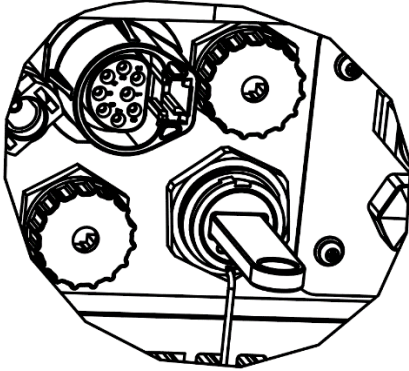

- Step 3: As soon as the USB-Disk is connected to the inverter, the upgrade menu will automatically appear on the display. After that press up and down to select the desired upgrade and press OK to confirm the upgrade.
- Step 4: After the upgrade is complete, pull out the USB-Drive. Screw the waterproof cover on the inverter closed.

7. Operation

7.1. Control Panel

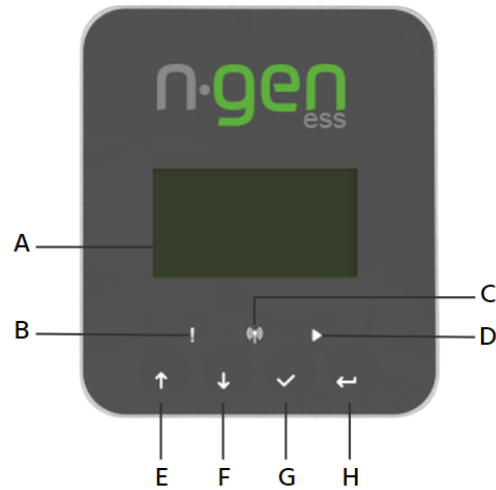

A	LCD Display	Displays information about the inverter
B	Indicator LED	Red: Displays inverter error
C		Blue: Inverter is properly connected to the battery
D		Green: Inverter is operating normally
E	Function Buttons	UP: Move cursor up or increase value
F		DOWN: Move cursor down or decrease value
G		OK: Confirm selection
H		BACK: Return to previous function

7.1. Function Tree

Function tree for single inverter operation:

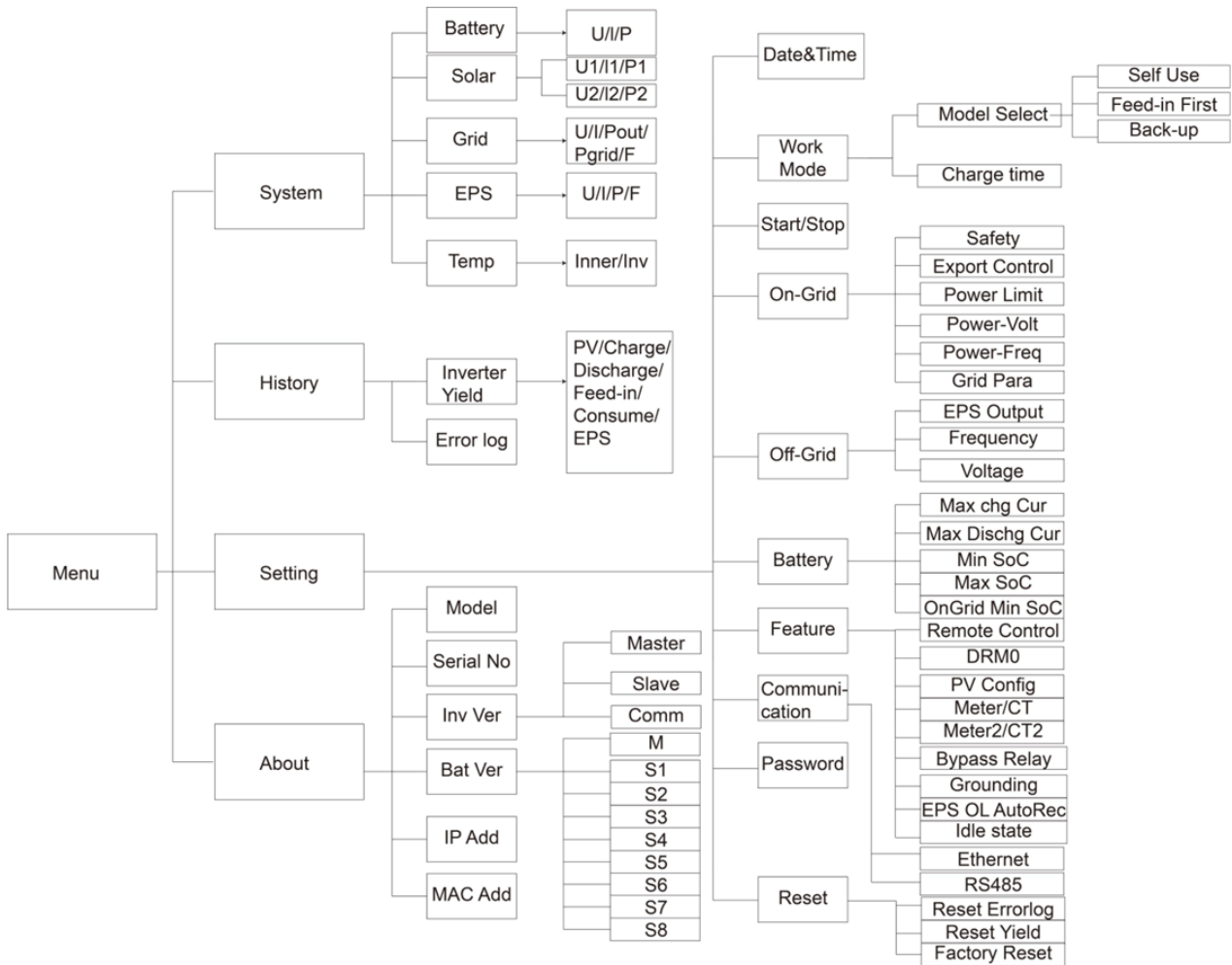

8. Connecting of an Existing Photovoltaic System to the NGEN Star System

8.1. Connection to „LOAD“ on the Smart Box

If an existing photovoltaic system is available and you wish to continue using it, you can connect it to the „LOAD“ wiring on the Smart Box, as shown in the diagram below:

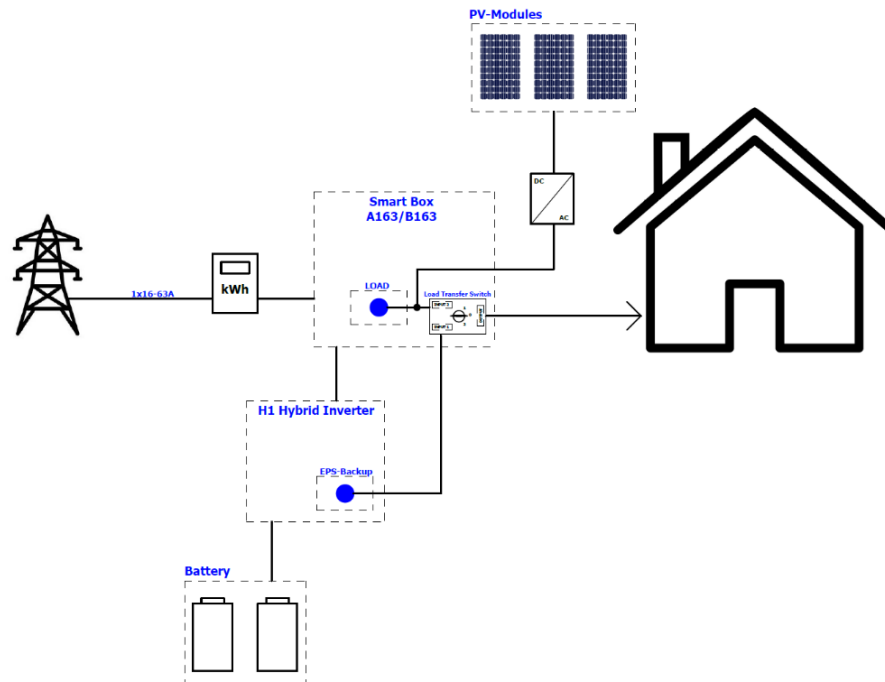

8.2. Connection of the Existing Photovoltaic system to NGEN Hybrid Inverter

If a customer has an existing photovoltaic system and wants to make it compatible with our NGEN-Star inverter, he must remove the existing inverter and connect the strings of the existing photovoltaic system directly to our hybrid inverter, as shown in the diagram below:

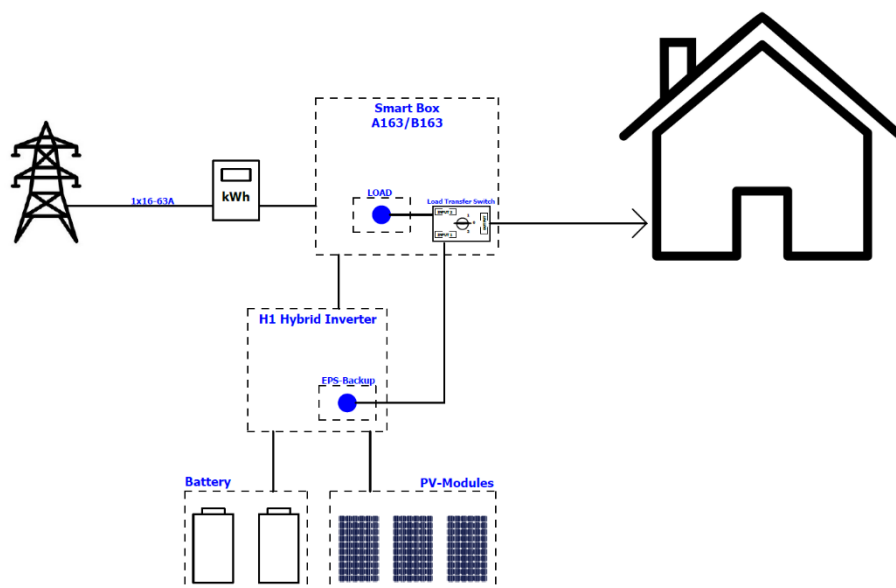

9. Synaptic-Unit part of Smart Box – Function of the relay outputs

The Synaptic unit integrated into the Smart Box features three relay outputs to which various production and consumption units can be connected. The function explanations for each relay you can find below:

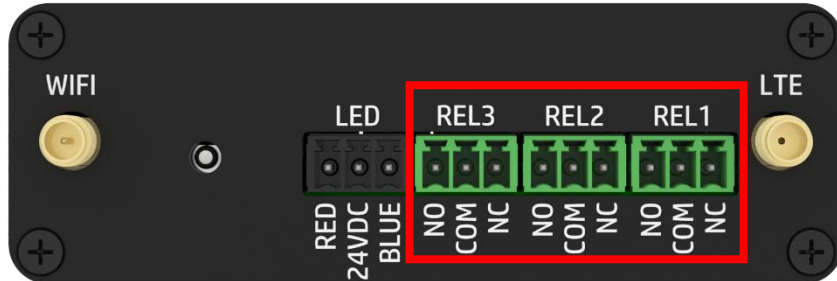

9.1. Relay 1 – Boost Mode

The Boost Mode allows you to take advantage of periods of low-cost or free electricity for devices that can store energy in the form of heat or increase consumption at certain intervals. This feature is ideal for heat pumps, electric heaters, and electric vehicles, which you can use when electricity is cheaper or free. With the Boost Mode, you will reduce your costs and increase energy efficiency by using energy when it is most advantageous. Especially when surplus energy from a photovoltaic system is used to optimize self-consumption.

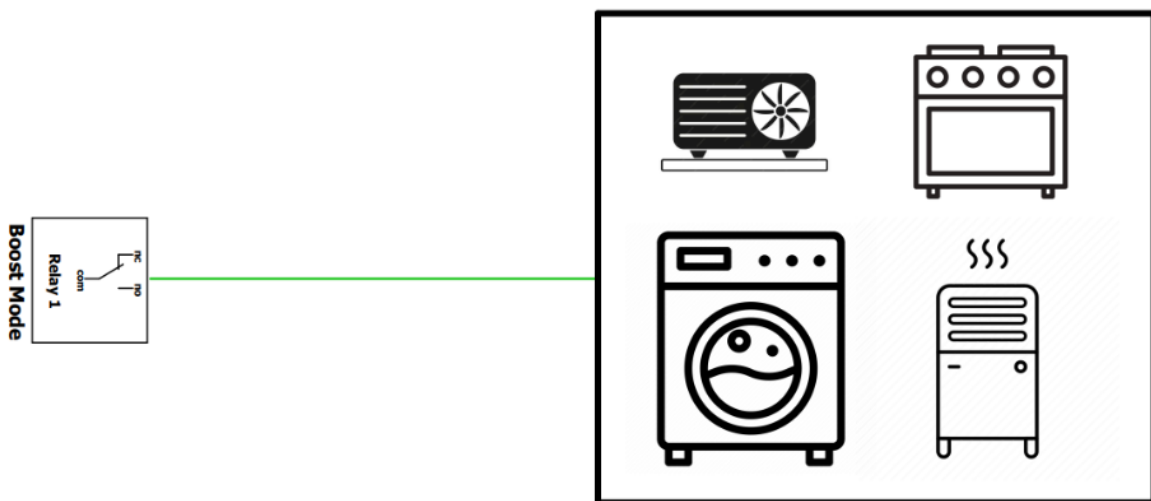

How It Works: Relay 1 is activated during intervals of reduced-price or free electricity.

Configuration: To enable this function, Relay 1 must be connected to your device so that the desired appliance turns on when the relay is activated. This allows automatic control of your device and maximizes the benefits of favourable electricity prices.

9.2. Relay 2 – Load Reduction Mode

The Load Reduction Mode is a feature that rewards you for energy-efficient behaviour. It encourages a reduction in electricity consumption by deactivating devices during times of high network load. This feature is ideal for devices such as heat pumps, electric heaters, and charging stations, which can be deactivated during periods when energy is expensive or when reducing consumption brings a reward.

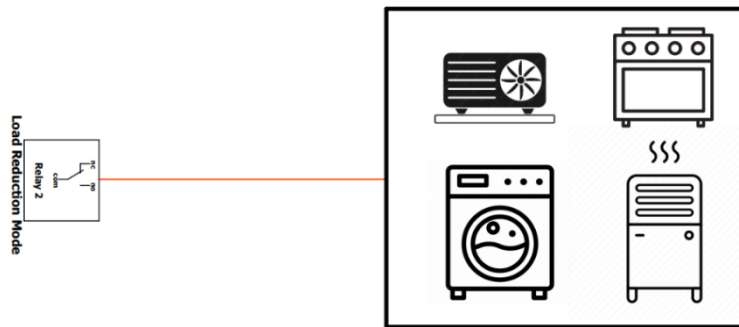

How It Works: Use devices connected to Load Reduction Mode (Relay 2) during these intervals to reduce your consumption. Receive a reward for participating in an energy-efficient program that helps stabilize the grid and reduce high network loads.

Configuration: To enable this function, Relay 2 must be connected to your device. When the relay is activated, your device will adjust to the optimal operating time, allowing you to save and earn rewards.

9.3. Relay 3 – Production Control

Production Control is a feature that helps you balance energy production and provides financial compensation for lost production. It is designed for users with solar power systems or other production units such as hydroelectric, wind or biomass plants that occasionally face disconnections or reduced production. With the Production Control, you can receive compensation for lost energy even when your system is not producing electricity for example during the activation of the negative tertiary reserves by the grid operator.

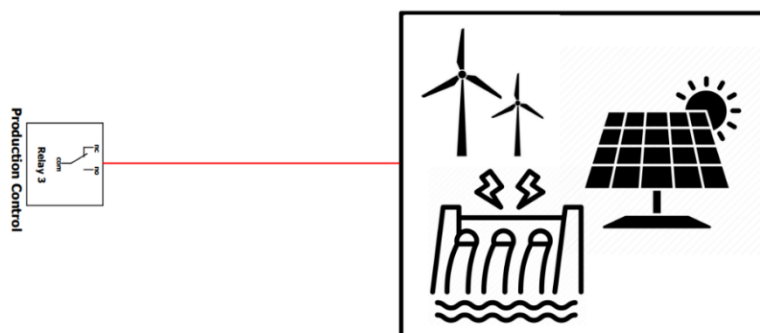

How It Works: In case of disconnections or reduced production, you receive simulated financial compensation for the lost energy.

Configuration: To enable this function, Relay 3 must be connected to your production unit, allowing monitoring and control of lost production. This way, you receive compensation and achieve a more stable return despite occasional interruptions.

10. Configuration of the Relais in the Smart Grid Connect App

After connecting the relay contacts to the intelligent devices, configuring the relays in the Smart Grid Connect app is necessary. Log in to the Smart Grid Connect app and open the desired system. Under the menu item Relay Control, you can perform the relay configuration. For all three relays, the user can define relay name and manually set time frames when the relay should be activated.

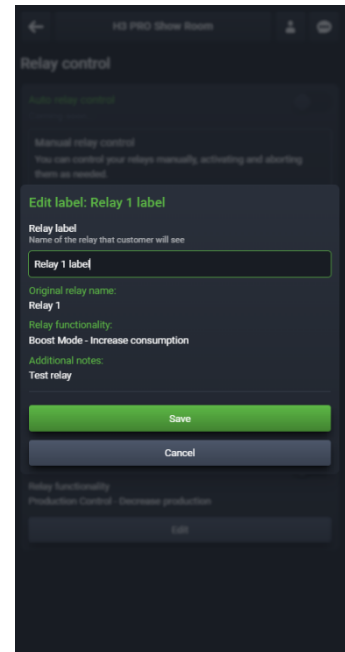
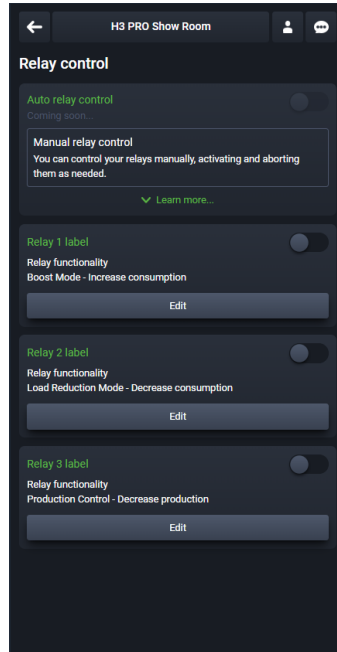

10.1. Synaptic Relay Specifications

The Smart Grid Ready function is controlled by relay 1 and 2 of the Synaptic part of NGEN Smart Box. Please find the technical Specifications of the relays below:

TECHNICAL SPECIFICATIONS	
Contact Arrangement	1: NC 2: COM 3: NO
Contact Resistance	< 50 milliohms initial
Maximum Switching Power	150 W
Maximum Switching Voltage	300VAC, 150VDC
Maximum Switching Current	5A

The switch between operating modes occurs automatically. The measured power at the household connection point is used for control. The use of individual relay functions can be configured via the mobile Smart Grid Connect app.

10.2. Schematic Diagram of Connections (Smart Box Type A and Type B)

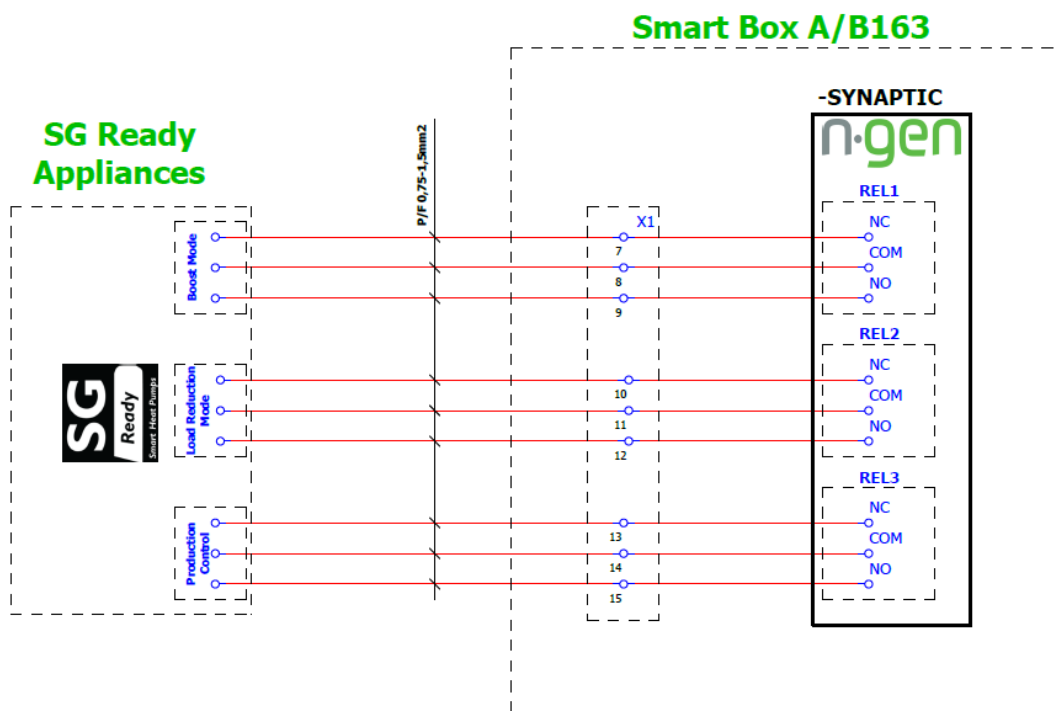

11. Maintenance

This chapter contains information and procedures for troubleshooting potential issues with NGEN Star inverters and provides you with tips for resolving them. To identify and resolve most issues that may arise, use the checklist below as a guide.

11.1. Alarm List

Error Code	Solution
Grid Lost Fault	<p>Lost grid connection.</p> <ul style="list-style-type: none"> The system switches back on when the power supply returns to normal. <p>If the unit does not return to normal operation, contact the manufacturer.</p>
Grid Volt Fault	<p>Grid voltage is not available.</p> <ul style="list-style-type: none"> The system switches back on when the power supply returns to normal. <p>If the unit does not return to normal operation, contact the manufacturer.</p>
Grid Freq Fault	<p>Grid frequency is not available.</p> <ul style="list-style-type: none"> The system switches back on when the power supply returns to normal. <p>If the unit does not return to normal operation, contact the manufacturer.</p>
10min Volt Fault	<p>The grid voltage has been out of reach for the last 10 minutes.</p> <ul style="list-style-type: none"> The system switches back on when the power supply returns to normal. <p>If the unit does not return to normal operation, contact the manufacturer.</p>
SW Inv Cur Fault	<p>The software has detected a high output current.</p> <ul style="list-style-type: none"> Disconnect the PV, grid, and battery, then reconnect. <p>If the unit does not return to normal operation, contact the manufacturer.</p>
DCI Fault	<p>The DC component is out of the output current limit.</p> <ul style="list-style-type: none"> Disconnect the PV, grid, and battery, then reconnect. <p>If the unit does not return to normal operation, contact the manufacturer.</p>
HW Inv Cur Fault	<p>The hardware has detected a high output current.</p> <ul style="list-style-type: none"> Disconnect the PV, grid, and battery, then reconnect. <p>If the unit does not return to normal operation, contact the manufacturer.</p>
SW Bus Volt Fault	<p>Bus voltage out of the range detected by the software.</p> <ul style="list-style-type: none"> Disconnect the PV, grid, and battery, then reconnect. <p>If the unit does not return to normal operation, contact the manufacturer.</p>

Bat Volt Fault	<p>Battery voltage error.</p> <ul style="list-style-type: none"> Check if the battery input voltage is within the normal range. <p>If the unit does not return to normal operation, contact the manufacturer.</p>
SW Bat Cur Fault	<p>The software has detected a high battery current.</p> <ul style="list-style-type: none"> Disconnect the PV, grid, and battery, then reconnect. <p>If the unit does not return to normal operation, contact the manufacturer.</p>
Iso Fault	<p>Insulation problems</p> <ul style="list-style-type: none"> Check if the insulation of the electrical wires is damaged. Wait a while, then check if it works normally again. <p>If the unit does not return to normal operation, contact the manufacturer.</p>
Res Cur Fault	<p>The Voltage is too high.</p> <ul style="list-style-type: none"> Check if the insulation of the electrical wires is damaged. Wait a while, then check if it works normally again. <p>If the unit does not return to normal operation, contact the manufacturer.</p>
Pv Volt Fault	<p>PV-Voltage is not available.</p> <ul style="list-style-type: none"> Please check the output voltage of the PV panels. <p>If the unit does not return to normal operation, contact the manufacturer.</p>
SW Pv Cur Fault	<p>The software has detected a high input PV current.</p> <ul style="list-style-type: none"> Disconnect the PV, grid, and battery, then reconnect. <p>If the unit does not return to normal operation, contact the manufacturer.</p>
Temp Fault	<p>The inverter temperature is too high.</p> <ul style="list-style-type: none"> Please check whether the ambient temperature is correct. Wait for a while, then check if it is working normally again. <p>If the unit does not return to normal operation, contact the manufacturer.</p>
Ground Fault	<p>Grounding connection failed.</p> <ul style="list-style-type: none"> Check the neutral and PE voltage. Check AC wiring. <p>Disconnect the PV, grid, and battery, then reconnect.</p> <p>If the unit does not return to normal operation, contact the manufacturer.</p>
Overload Fault	<p>Overload fault.</p> <ul style="list-style-type: none"> Check if the maximum power consumption has been exceeded. Check if the loads have overloaded the device. <p>If the unit does not return to normal operation, contact the manufacturer.</p>
Eps Overload	<p>Overload in backup operation</p> <ul style="list-style-type: none"> Check if the maximum power consumption on the EPS connection has been exceeded. Check if the loads have overloaded the device in backup power supply. <p>If the unit does not return to normal operation, contact the manufacturer.</p>

Bat Power Low	<p>Battery power is low.</p> <ul style="list-style-type: none"> • Wait for the battery to recharge. <p>If the unit does not return to normal operation, contact the manufacturer.</p>
HW Bus Volt Fault	<p>Bus voltage outside the range detected by the hardware.</p> <ul style="list-style-type: none"> • Disconnect the PV, grid, and battery, then reconnect. <p>If the unit does not return to normal operation, contact the manufacturer.</p>
HW Pv Cur Fault	<p>PV current is out of permissible values.</p> <ul style="list-style-type: none"> • Disconnect the PV, grid, and battery, then reconnect. <p>If the unit does not return to normal operation, contact the manufacturer.</p>
HW Bat Cur Fault	<p>Battery current is out of permissible values.</p> <ul style="list-style-type: none"> • Disconnect the PV, grid, and battery, then reconnect. <p>If the unit does not return to normal operation, contact the manufacturer.</p>
SCI Fault	<p>Communication between master and controller is interrupted.</p> <ul style="list-style-type: none"> • Disconnect the PV, grid, and battery, then reconnect. <p>If the unit does not return to normal operation, contact the manufacturer.</p>
MDSP SPI Fault	<p>Communication between master and controller is interrupted.</p> <ul style="list-style-type: none"> • Disconnect the PV, grid, and battery, then reconnect. <p>If the unit does not return to normal operation, contact the manufacturer.</p>
MDSP Smpl Fault	<p>Sampling device on master inverter is not working</p> <ul style="list-style-type: none"> • Disconnect the PV, grid, and battery, then reconnect. <p>If the unit does not return to normal operation, contact the manufacturer.</p>
Res Cur HW Fault	<p>RCD protective switch is not working.</p> <ul style="list-style-type: none"> • Disconnect the PV, grid, and battery, then reconnect. <p>If the unit does not return to normal operation, contact the manufacturer.</p>
Inv EEPROM Fault	<p>EEPROM on the inverter is not working.</p> <ul style="list-style-type: none"> • Disconnect the PV, grid, and battery, then reconnect. <p>If the unit does not return to normal operation, contact the manufacturer.</p>
PvCon Dir Fault	<p>Error on PV bus</p> <ul style="list-style-type: none"> • Check if the positive and negative poles of the PV bus are properly connected. <p>If the unit does not return to normal operation, contact the manufacturer.</p>
Bat Relay Open	<p>Battery relay is open.</p> <ul style="list-style-type: none"> • Disconnect the PV, grid, and battery, then reconnect. <p>If the unit does not return to normal operation, contact the manufacturer.</p>
Bat Relay Short Circuit	<p>Battery relay is closed</p> <ul style="list-style-type: none"> • Disconnect the PV, grid, and battery, then reconnect. <p>If the unit does not return to normal operation, contact the manufacturer.</p>

Bat Buck Fault	<p>Mosfet on the battery is defective.</p> <ul style="list-style-type: none"> • Disconnect the PV, grid, and battery, then reconnect. <p>If the unit does not return to normal operation, contact the manufacturer.</p>
Bat Boost Fault	<p>Mosfet on the battery is defective.</p> <ul style="list-style-type: none"> • Disconnect the PV, grid, and battery, then reconnect. <p>If the unit does not return to normal operation, contact the manufacturer.</p>
Eps Relay Fault	<p>The relay on the EPS connection is faulty.</p> <ul style="list-style-type: none"> • Disconnect the PV, grid, and battery, then reconnect. <p>If the unit does not return to normal operation, contact the manufacturer.</p>
BatCon Dir Fault	<p>Battery connection is faulty.</p> <ul style="list-style-type: none"> • Check if the positive and negative poles of the battery are connected correctly. <p>If the unit does not return to normal operation, contact the manufacturer.</p>
Grid Relay Fault	<p>The grid relay remains open or closed.</p> <ul style="list-style-type: none"> • Disconnect the PV, grid, and battery, then reconnect. <p>If the unit does not return to normal operation, contact the manufacturer.</p>
S1 Close Fault	<p>The grid relay S1 keep close.</p> <ul style="list-style-type: none"> • Disconnect the PV, grid, and battery, then reconnect. <p>If the unit does not return to normal operation, contact the manufacturer.</p>
S2 Close Fault	<p>The grid relay S2 keep close.</p> <ul style="list-style-type: none"> • Disconnect the PV, grid, and battery, then reconnect. <p>If the unit does not return to normal operation, contact the manufacturer.</p>
M1 Close Fault	<p>The grid relay M1 keep close.</p> <ul style="list-style-type: none"> • Disconnect the PV, grid, and battery, then reconnect. <p>If the unit does not return to normal operation, contact the manufacturer.</p>
M2 Close Fault	<p>The grid relay M2 keep close.</p> <ul style="list-style-type: none"> • Disconnect the PV, grid, and battery, then reconnect. <p>If the unit does not return to normal operation, contact the manufacturer.</p>
GridV Cons Fault	<p>The grid voltage sample value between master and slave is not consistent.</p> <ul style="list-style-type: none"> • Disconnect the PV, grid, and battery, then reconnect. <p>If the unit does not return to normal operation, contact the manufacturer.</p>
GridF Cons Fault	<p>The grid frequency sample value between master and slave is not consistent.</p> <ul style="list-style-type: none"> • Disconnect the PV, grid, and battery, then reconnect. <p>If the unit does not return to normal operation, contact the manufacturer.</p>

DCI Cons Fault	<p>The dci sample value between master and slave is not consistent</p> <ul style="list-style-type: none"> • Disconnect the PV, grid, and battery, then reconnect. <p>If the unit does not return to normal operation, contact the manufacturer.</p>
Rc Cons Fault	<p>The residential current sample value between master and slave is not consistent</p> <ul style="list-style-type: none"> • Disconnect the PV, grid, and battery, then reconnect. <p>If the unit does not return to normal operation, contact the manufacturer.</p>
RDSP SPI Fault	<p>Communication between master and controller is interrupted.</p> <ul style="list-style-type: none"> • Disconnect the PV, grid, and battery, then reconnect. <p>If the unit does not return to normal operation, contact the manufacturer.</p>
RDSP Smpl Fault	<p>Sampling device on the subordinate inverter is faulty.</p> <ul style="list-style-type: none"> • Disconnect the PV, grid, and battery, then reconnect. <p>If the unit does not return to normal operation, contact the manufacturer.</p>
ARM EEPROM Fault	<p>The manager EEPROM is faulty.</p> <ul style="list-style-type: none"> • Disconnect the PV, grid, and battery, then reconnect. <p>If the unit does not return to normal operation, contact the manufacturer.</p>
Meter Lost Fault	<p>Communication between the inverter and the meter is disrupted.</p> <ul style="list-style-type: none"> • Check if the communication cable between the meter and the inverter is connected correctly. <p>If the unit does not return to normal operation, contact the manufacturer.</p>
BMS Lost	<p>Communication between the BMS and inverter is disrupted.</p> <ul style="list-style-type: none"> • Check if the communication cable between the battery and the inverter is connected correctly. <p>If the unit does not return to normal operation, contact the manufacturer.</p>
Bms Ext Fault	<p>Communication between the BMS and inverter is disrupted</p> <ul style="list-style-type: none"> • Check if the communication cable between the battery and the inverter is connected correctly. <p>If the unit does not return to normal operation, contact the manufacturer.</p>
Bms Int Fault	<p>DIP switch is in the wrong position. Communication between batteries is interrupted.</p> <ul style="list-style-type: none"> • Move the DIP-Switch to the correct position • Check if the communication cable between the BMS and the inverter is connected correctly.
Bms Volt High	<p>BMS is supplied with too high voltage.</p> <ul style="list-style-type: none"> • Contact the battery manufacturer.
Bms Volt Low	<p>BMS is supplied with too low voltage.</p> <ul style="list-style-type: none"> • Contact the battery manufacturer.

Bms ChgCur High	<p>Battery charging current is too high.</p> <ul style="list-style-type: none"> • Contact the battery manufacturer.
Bms DchgCur High	<p>Battery discharge current is too high.</p> <ul style="list-style-type: none"> • Contact the battery manufacturer.
Bms Temp High	<p>Battery temperature is too high.</p> <ul style="list-style-type: none"> • Contact the battery manufacturer.
Bms Temp Low	<p>Battery temperature is too low</p> <ul style="list-style-type: none"> • Contact the battery manufacturer.
BmsCellImbalance	<p>Cell capacities are different.</p> <ul style="list-style-type: none"> • Contact the battery manufacturer.
Bms HW Protect	<p>BMS protection has been activated.</p> <ul style="list-style-type: none"> • Contact the battery manufacturer.
BmsCircuit Fault	<p>Hardware circuit fault in the battery.</p> <ul style="list-style-type: none"> • Contact the battery manufacturer.
Bms Insul Fault	<p>Battery insulation fault.</p> <ul style="list-style-type: none"> • Contact the battery manufacturer.
Bms VoltsSen Fault	<p>Battery voltage sensor fault.</p> <ul style="list-style-type: none"> • Contact the battery manufacturer.
Bms TempSen Fault	<p>Battery temperature sensor fault.</p> <ul style="list-style-type: none"> • Contact the battery manufacturer.
BmsCurSen Fault	<p>Battery current sensor fault.</p> <ul style="list-style-type: none"> • Contact the battery manufacturer.
Bms Relay Fault	<p>Battery relay error.</p> <ul style="list-style-type: none"> • Contact the battery manufacturer.

Bms Type Unmatch	<p>Different battery capacities.</p> <ul style="list-style-type: none"> • Contact the battery manufacturer.
Bms Ver Unmatch	<p>BMS firmware between the battery modules is different.</p> <ul style="list-style-type: none"> • Contact the battery manufacturer.
Bms Mfg Unmatch	<p>Different battery cell manufacturers.</p> <ul style="list-style-type: none"> • Contact the battery manufacturer.
Bms SwHw Unmatch	<p>BMS firmware does not match the installed components.</p> <ul style="list-style-type: none"> • Contact the battery manufacturer.
Bms M&S Unmatch	<p>The software between the master and slave batteries does not match.</p> <ul style="list-style-type: none"> • Contact the battery manufacturer.
Bms ChgReq NoAck	<p>No charging demand</p> <ul style="list-style-type: none"> • Contact the battery manufacturer.

11.2. Troubleshooting and Regular Maintenance

Troubleshooting

- Please check the error message on the inverter control panel. If an error message is displayed, make a note of it before taking any further action.
- Try to find a solution in the above table.
- If the information panel of the inverter does not display an error message, check the following to ensure that the current state of the installation allows the device to operate properly:
 1. Is the inverter located in a clean, dry and adequately ventilated area?
 2. Are the DC disconnect switches open?
 3. Are the cables of the appropriate size?
 4. Are the input and output connectors, and the cabling, in good condition?
 5. Are the configuration settings correct for your installation?
 6. Are the display panel and communication cable properly connected and undamaged?

For further assistance, please contact the NGEN customer service. Please be prepared to describe details of your system installation and provide the model and serial number of the device.

Safety Inspection

A safety inspection must be carried out at least every 12 months by a qualified technician who has the necessary training, knowledge, and practical experience to perform these tests. The data must be recorded in the equipment logbook. If the device is not functioning properly or does not pass any of the tests, it must be repaired. For details of the safety check, refer to Chapter 2 of this manual.

Maintenance Checklists

During the operation of the inverter, the responsible person must regularly inspect and maintain the device regularly. The required actions are as follows:

- Check if dust / dirt has accumulated in the cooling fins on the back of the inverter and clean the inverter if necessary. This work should be carried out at regular intervals.
- Check if the inverter indicators are in normal condition or if the inverter display is working properly. These inspections should be done at least every 6 months.
- Check if the input and output cables are damaged or old. This inspection should be done at least every 6 months.
- Clean the surface of the inverter and check their safety at least every 6 months.

Note: Only qualified personnel can perform the above-described work.

12. Shutdown

12.1. Switching off the inverter

Please follow the steps below to switch off the inverter:

1. Open the setting page, select START / STOP, and stop the inverter.
2. Turn off the PV / DC switch, the AC breaker, the EPS breaker, and the circuit breaker on the battery.
3. Wait 5 minutes before opening the top cover to ensure that the capacitors inside the inverter discharge. (if it needs repairing).

12.2. Inverter Dismantling

- Disconnect the inverter from the DC input and AC output. Wait 5 minutes until the inverter is completely de-energized.
- Disconnect the communication and other connected devices. Remove the inverter from the mounting bracket.
- Remove the mounting bracket if necessary.

12.3. Packaging

If possible, please pack the inverters in the original packaging. If the original packaging is no longer available, you can also use equivalent packaging that meets the following requirements.

- Suitable for loads of more than 30kg.
- Includes a carrying handle.
- Can be completely closed.

12.4. Storage and Transport

Store the inverters in a dry place where the ambient temperature is always between -40°C and +70°C. Ensure that the inverters are not stacked more than four boxes high during storage and transportation. If the inverter or other associated components need to be disposed of, please ensure that this is done in accordance with local regulations for waste disposal. Ensure that each inverter that is to be discarded is delivered to a location suitable for the disposal of this type of waste, in compliance with applicable regulations.

13. Attachment

13.1. Example of integrating the NGEN-Star Hybrid System in a Household

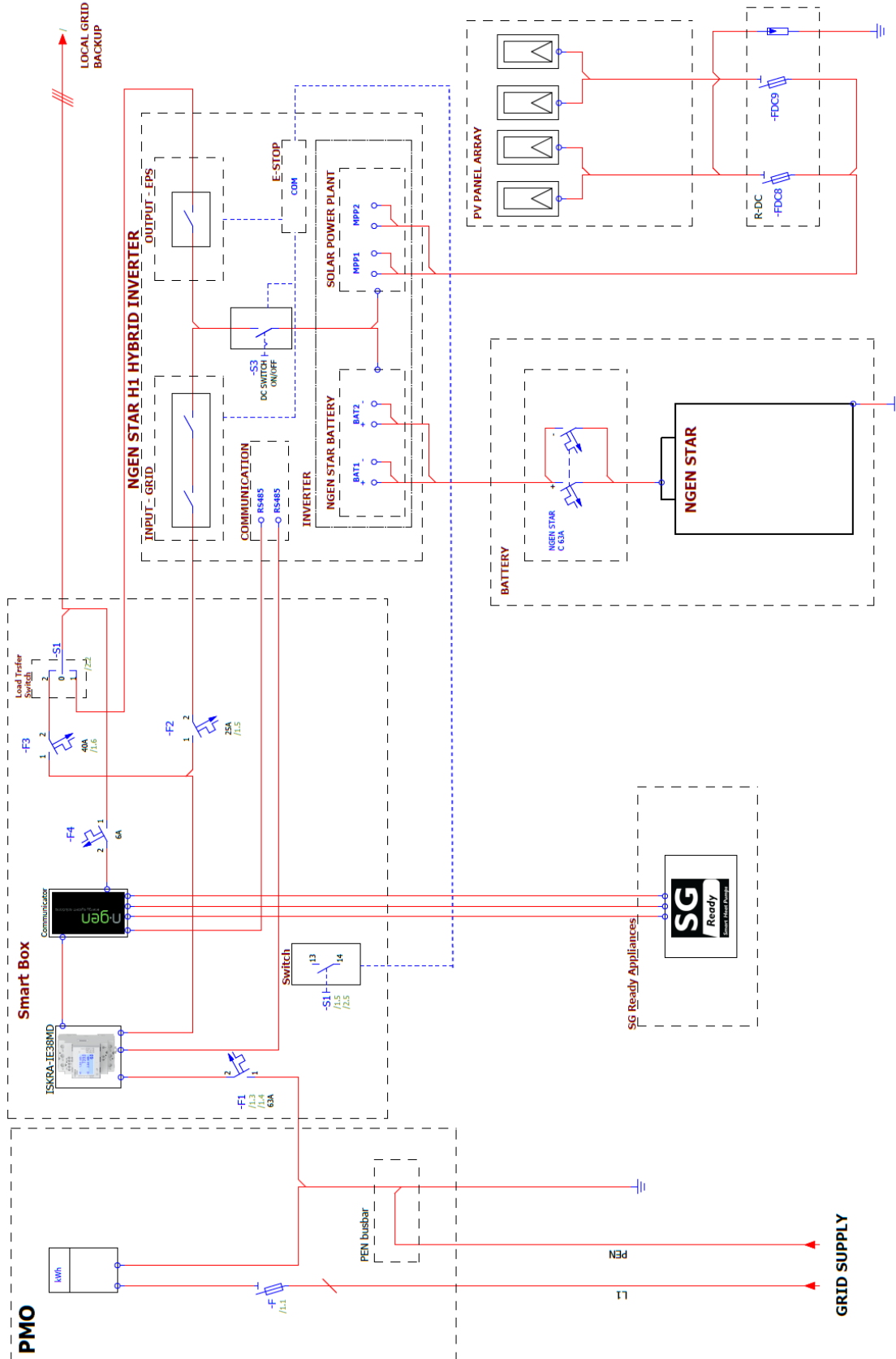

13.2. Connection of the NGEN-Star Hybrid Inverter-H1 with the Smart Box

13.2.1. AC-Connection Diagram

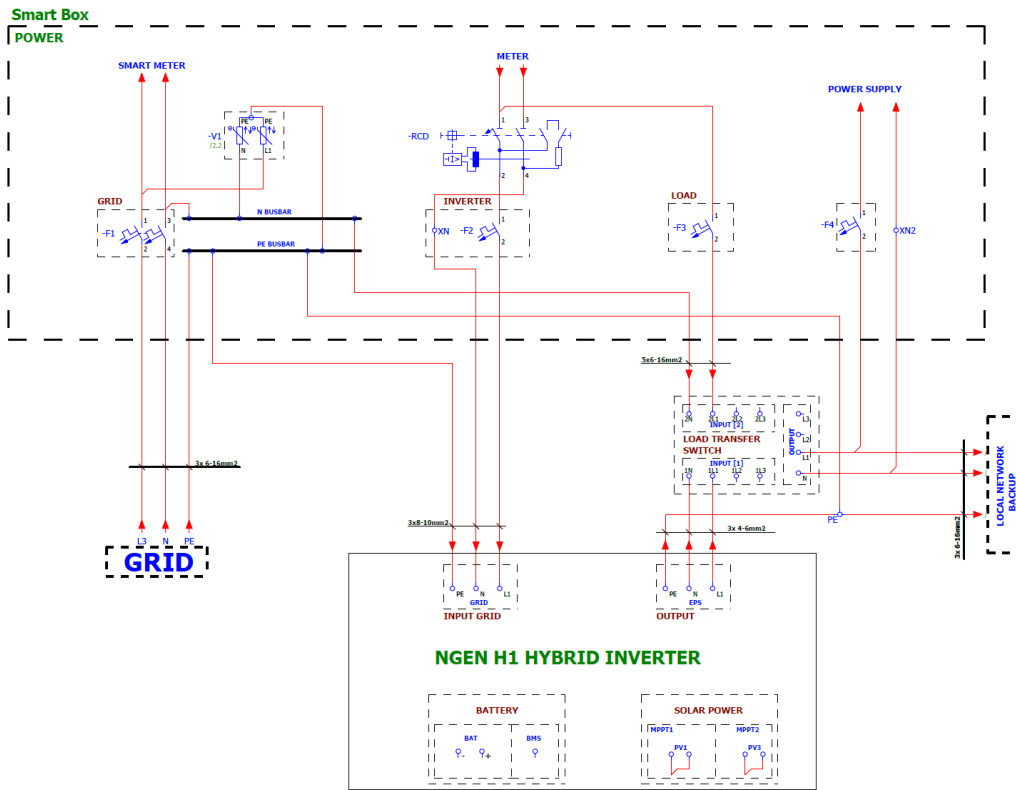

13.2.2. DC-Connection Diagram

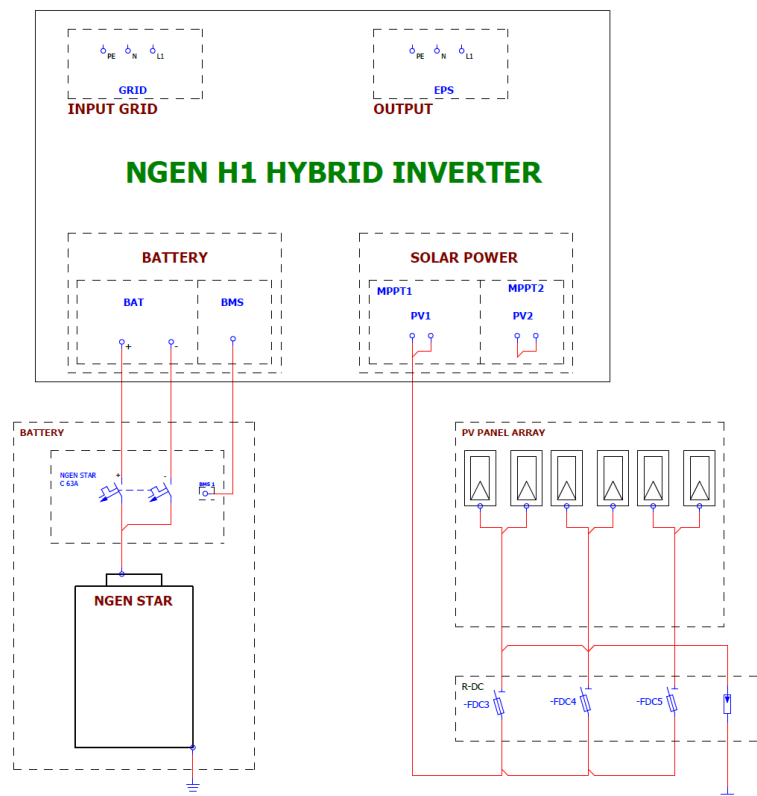

13.2.3. Communication-Connection Diagram

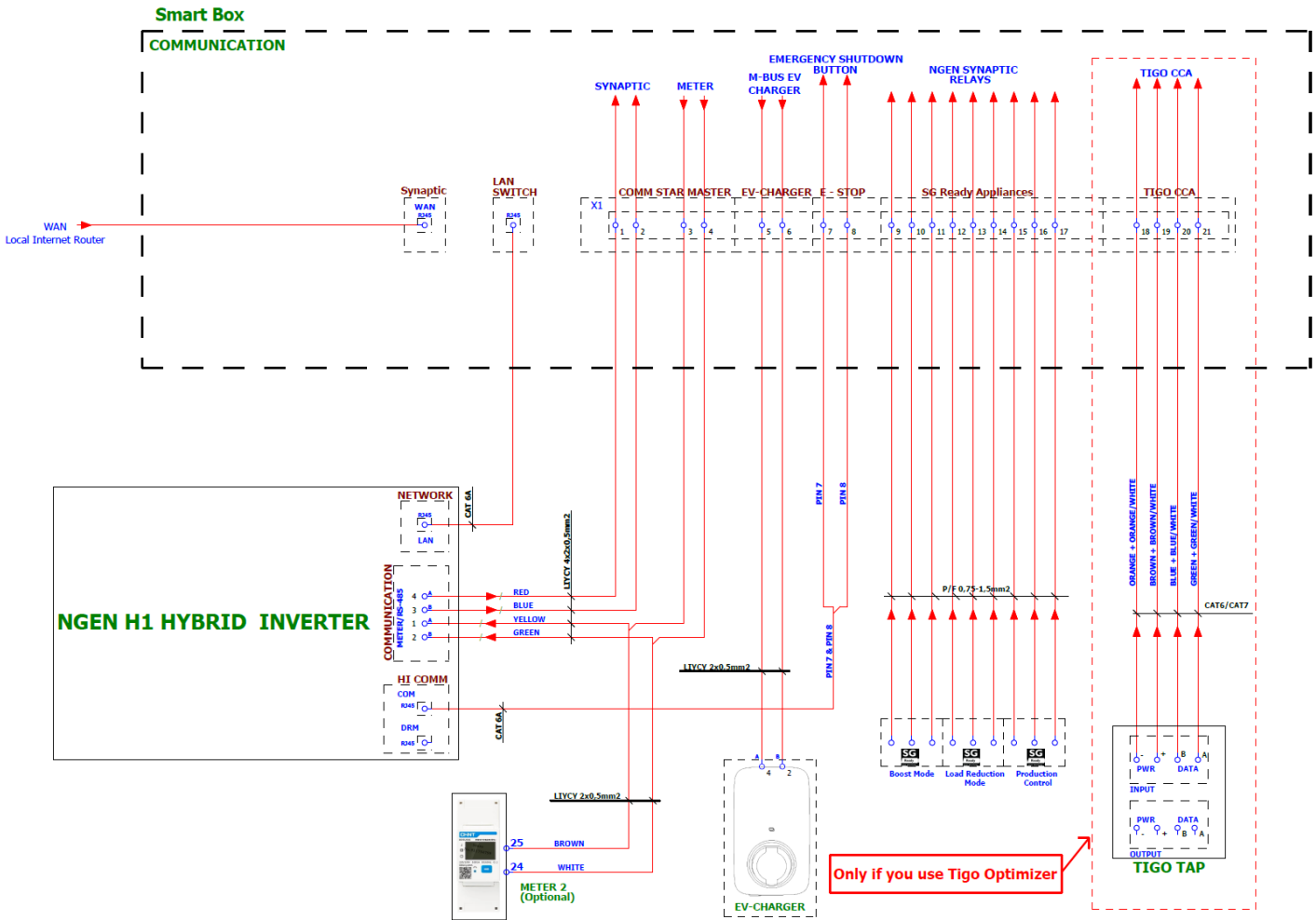

The copyright of this manual belongs to NGEN d.o.o. No legal or physical person may copy this manual, either in part or in full (including software), nor is any distribution or reproduction of the manual in any form or manner permitted. All rights reserved by NGEN d.o.o., Moste 101, 4274 Žirovnica, Slovenia. www.NGEN.si