

INSTALLATION INSTRUCTION

SMART BOX

A163 /B163



Table of Contents

1.	Hints for this Manual	4
1.1.	Range of Validity	4
1.2.	Target Group	4
1.3.	Used Symbols	4
2.	Use and Safety	5
2.1.	Proper Use of the Product	5
2.1.1.	System authorisation	5
2.1.2.	Tasks of the Smart Box	5
2.1.3.	Configuration Schematic	6
2.2.	Safety Instructions	6
3.	Smart Box Layout.....	7
3.1.	Depth of the Smart Box.....	7
3.2.	Height and width of the Smart Box.....	7
3.3.	Smart Box Components	8
3.4.	Difference between the A163 and B163 Smart Box	9
4.	Technical Specifications.....	10
4.1.	Smart Box A163.....	10
4.2.	Smart Box B163.....	10
5.	Installation.....	11
5.1.	Scope of delivery.....	11
5.2.	Requirements for the installation location	11
5.3.	Required tools.....	12
5.4.	Assembly Steps	12
6.	Electrical Connection.....	14
6.1.	Cable entries and fittings	14
6.2.	AC-Connection	14
6.3.	Communication Connection	15
6.3.1.	Smart Box A163	15
6.3.2.	Smart Box B163	15
6.4.	Internet Connection.....	16
6.5.	Connection Diagrams.....	17
6.5.1.	Connection Diagram NGEN-Star H1-Inverter	17
6.5.1.1.	AC-Connection	17

6.5.1.2.	DC-Connection.....	17
6.5.1.3.	Communication-Connection.....	18
7.	Function of the Synaptic relay outputs	19
7.1.	Relay 1 – Boost Mode	19
7.2.	Relay 2 – Load Reduction Mode	19
7.3.	Relay 3 – Production Control	20
8.	Configuration of the Relais in the Smart Grid Connect App.....	21
9.	Shutdown Button Function	22
10.	Shutdown Button with LED Indicator.....	23
11.	Commissioning of the Smart Box	24
11.1.	Requirements.....	24
11.2.	Start-up Steps.....	24
11.3.	Commissioning the Smart Box with the SG-Connect APP	24
12.	Maintenance and Cleaning.....	30
12.1.	Cleaning the Smart Box.....	30
13.	Storage	30
14.	Disposal	30
15.	Disclaimer	30

ENGLISH

Read this installation instruction carefully before installation. Failure to do so may result in personal injury and damage to property or invalidate the warranty and product guarantee. Installation requires specialist knowledge and may therefore only be carried out by appropriately qualified and authorized specialists!

The general handling of the product, its use or the exact installation methods are beyond the control of NGEN. Therefore, NGEN cannot accept any responsibility for damages, losses or cost resulting from improper installation, improper handling of the incorrect use!

1. Hints for this Manual

1.1. Range of Validity

The document describes the installation, commissioning, maintenance and troubleshooting for the product:

Smart Box A163 / B163





Note: Please keep these instructions in a place where they are always accessible.

1.2. Target Group

This manual is intended for qualified electricians. The tasks described in this manual can only be performed by qualified electricians.

1.3. Used Symbols

The following types of safety instructions and general information appear in this document as described below:

	<p>Danger! "Danger" indicates a hazardous situation which, if not avoided, will result in death or serious injury.</p>
	<p>Warning! "Warning" indicates a hazardous situation which, if not avoided, could result in death or serious injury.</p>
	<p>Caution! "Caution" indicates a hazardous situation which could result in minor or moderate injury if not avoided.</p>
	<p>Note! "Note" provides important tips and instructions.</p>

This section explains the symbols shown on the type of plate:

	<p>CE labelling The Smart Box complies with the requirements of the applicable CE directives.</p>
	<p>Protection class IP54 The Smart Box is fully protected against splashing water.</p>
	<p>Rated operating Voltage [V] Do not operate the Smart Box on any other mains voltage than that specified.</p>
	<p>Rated operating Frequency [Hz] Do not operate the Smart Box at any other operating frequency than specified.</p>
	<p>Peak-Current [A] The Smart Box may be operated up to this current.</p>
	<p>IEC/EN – Standard reference The Smart Box fulfils the requirements of: EN 61439-1 and EN61439-2</p>

2. Use and Safety

2.1. Proper Use of the Product

2.1.1. System authorisation

The Smart Box A163/B163 may only be used in combination with hybrid inverters from NGEN (models NGEN-STAR H1) or NGEN’s approved hybrid inverters.

2.1.2. Tasks of the Smart Box

- The Smart Box is installed on the main entry point of the house and is supplying the whole household loads.
- Supplying the hybrid inverter with AC voltage.
- Measurement and transmission of the parameters required for energy management and the SG-Connect App using the integrated smart meter.
- Controlling of intelligent devices (Heat pumps, Electric Heater or other SG-Ready compatible devices) for the energy management using the Synaptic Unit.
- Activation of the inverter’s emergency shutdown (E-Stop) by pressing the shutdown button on the Smart Box.
- By using the Smart Box A163 there is a communicator for TIGO-Optimizers included. With this TIGO-Communicator all relevant safety functions of the optimizers, such as the safety shutdown of the module optimizers, can be performed.
- With the preinstalled selector switch, it is possible to choose whether the house loads are supplied via the grid or the emergency supply from the inverter.

2.1.3. Configuration Schematic

NGEN-STAR-H1 Inverter:

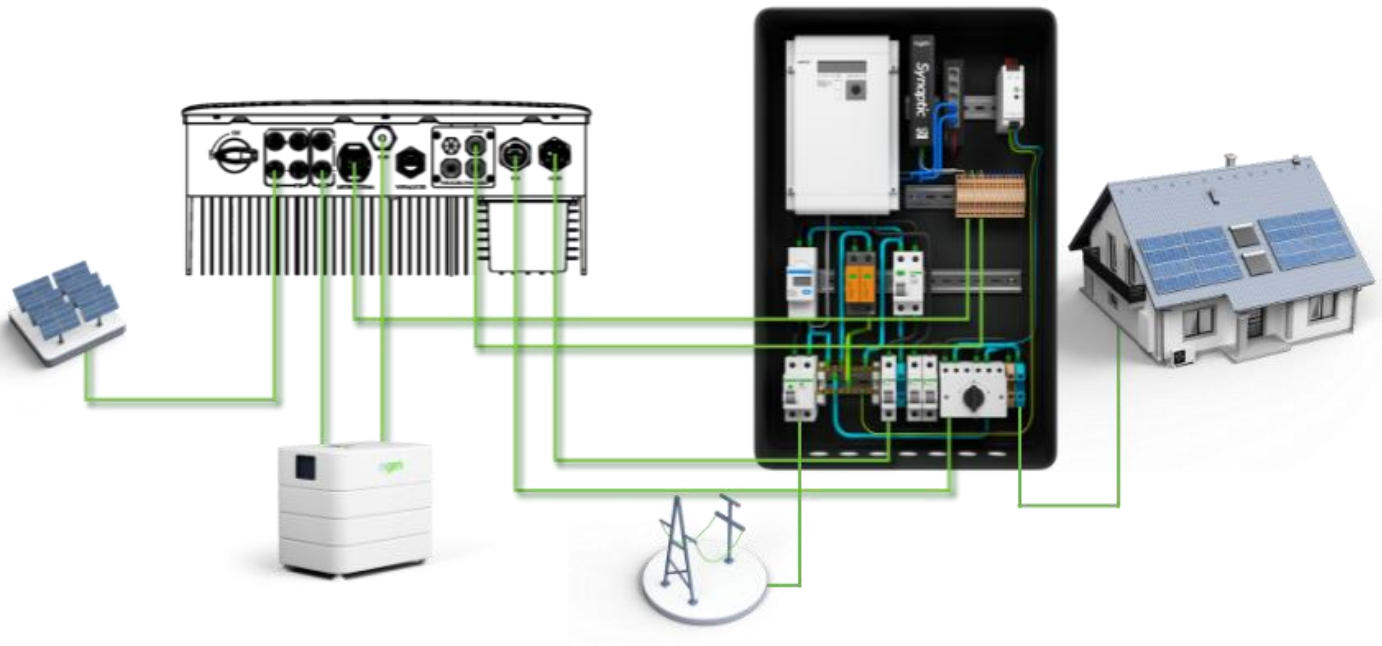

2.2. Safety Instructions

	<p>Danger! Danger to life due high voltages! The installation and commissioning of the Smart Box may only be carried out by trained / certified electricians.</p>
--	--

The Smart Box has been designed to ensure that all components, such as

- Circuit breakers
- Residual current device (RCD)
- Operation of the Smart Meter
- Operation of the shutdown button

can be operated by laypersons. This means that, for example, mandatory testing of the residual current circuit breaker (Test button) can also be carried out by non-specialists. In addition, various operating states can be ready on the Smart Meter.

3. Smart Box Layout

3.1. Depth of the Smart Box



3.2. Height and width of the Smart Box

In this drawing, you can find not only the dimensions of height and width but also the positions of the mounting holes for wall installation.

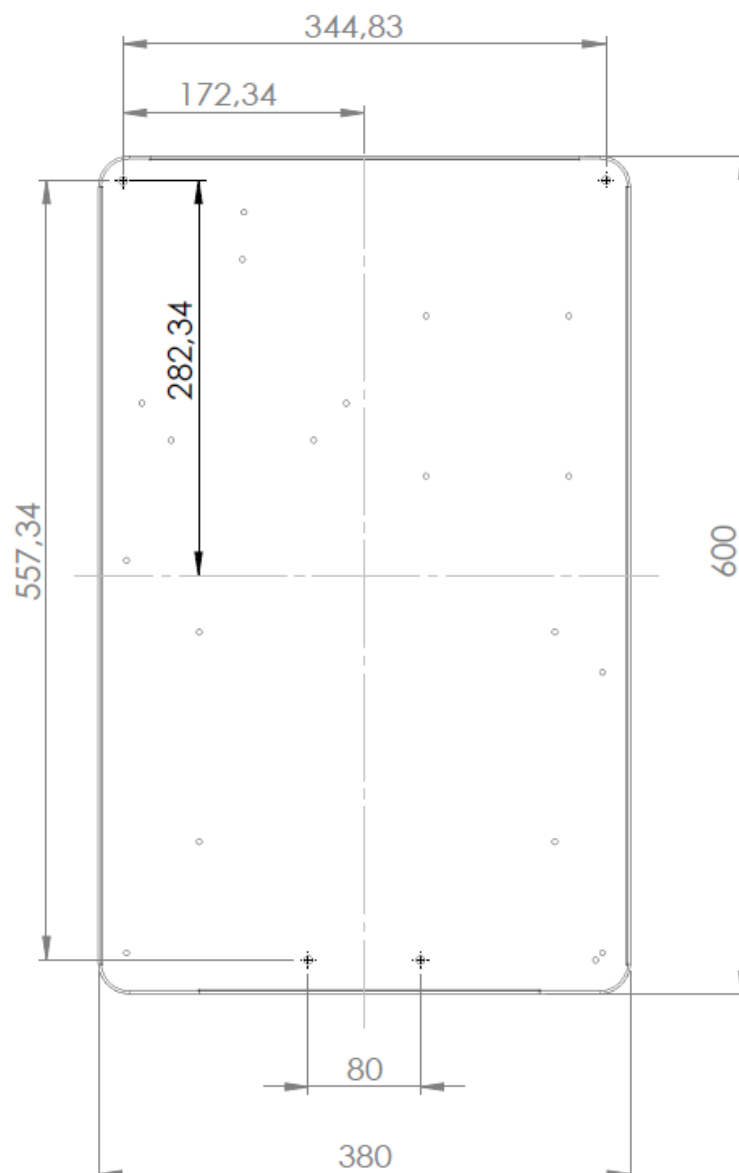

3.3. Smart Box Components

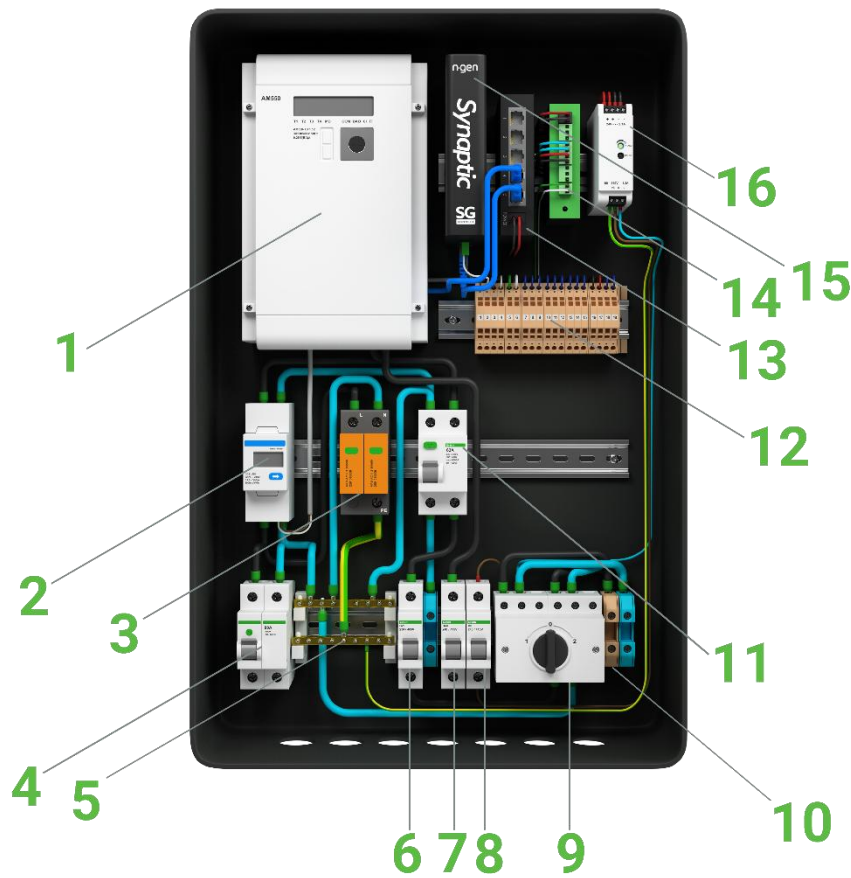

Number	Description	Number	Description
1	Certified Calibrated ISKRA Meter	9	Load Transfer Switch
2	Smart Meter for the hybrid inverter	10	Connection Terminals for the Household Loads
3	Overvoltage protection (Type II)	11	RCD – Residual Current device for the inverter (63A ; 100mA)
4	Circuit Breaker – Input Grid (63A)	12	Connection Terminals for (Inverter Connection, E-Stop Inverter, Intelligent devices, TIGO-Optimizers)
5	N and PE Busbar	13	Internet-Switch
6	Circuit Breaker – Output AC-Supply for the Inverter (B25A)	14	Communicator for TIGO-Optimizers (Only for A163)
7	Circuit Breaker – Output AC-Supply for the Household loads (B40A)	15	Synaptic-Unit (Energy management)
8	DC-Power supply for (Synaptic, Internet Switch, TIGO Communicator)	16	DC-Power supply for (Synaptic, Internet Switch, TIGO Communicator)

3.4. Difference between the A163 and B163 Smart Box

The Smart Box is available in two different versions:

- Smart Box A163: Including the Communicator for TIGO-Optimizers
- Smart Box B163: Without the Communicator for TIGO-Optimizers

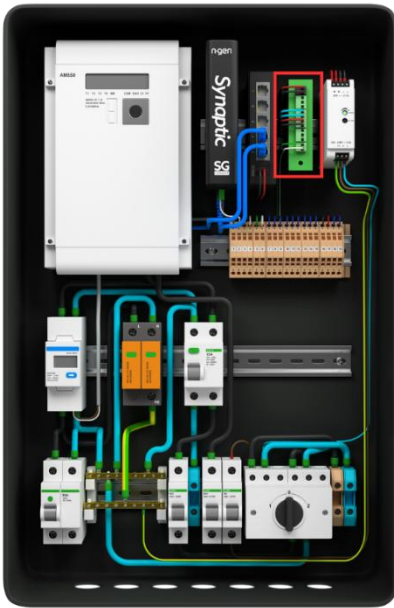

Figure 2 Smart Box A163

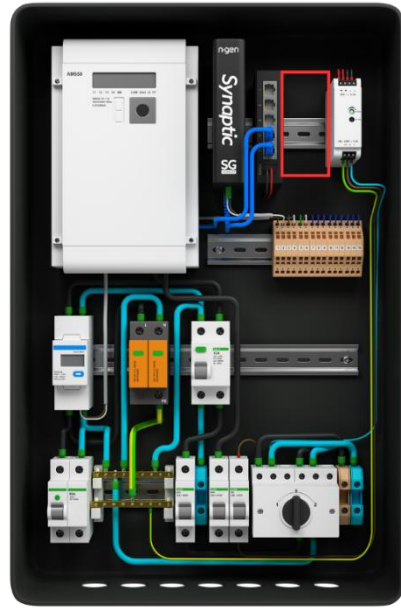

Figure 1 Smart Box B163



Note!

The installed TIGO optimizers on the photovoltaic modules maximize the energy yield of your system and minimize losses due to shading or adjustments to the module field.

4. Technical Specifications

4.1. Smart Box A163

Model	Smart Box A163
ELECTRICAL SPECIFICATIONS	
Rated Voltage [Un] [Vac]	1x 230
Rated Frequency [Hz]	50
Rated Current [In] [A]	63
GENERAL DATA	
Dimensions [H*W*D]	640 * 420 * 130
Weight [kg]	19.2
Protection	IP54
Communicator for TIGO-Optimizers	YES
IEC/EN - Standard	EN 61439-1 & EN 61439-2

4.2. Smart Box B163

Model	Smart Box B363
ELECTRICAL SPECIFICATIONS	
Rated Voltage [Un] [Vac]	1x 230
Rated Frequency [Hz]	50
Rated Current [In] [A]	63
GENERAL DATA	
Dimensions [H*W*D]	640 * 420 * 130
Weight [kg]	19.2
Protection	IP54
Communicator for TIGO-Optimizers	NO
IEC/EN - Standard	EN 61439-1 & EN 61439-2

5. Installation

Before installing the device, make sure that the Smart Box has not been damaged during transport. If there are visible damages, such as cracks, please contact the product seller immediately.

5.1. Scope of delivery

The delivery includes the pre-installed Smart Box along with the corresponding installation and wiring instructions. Additionally, a pair of keys is provided to lock or unlock the Smart Box as needed.

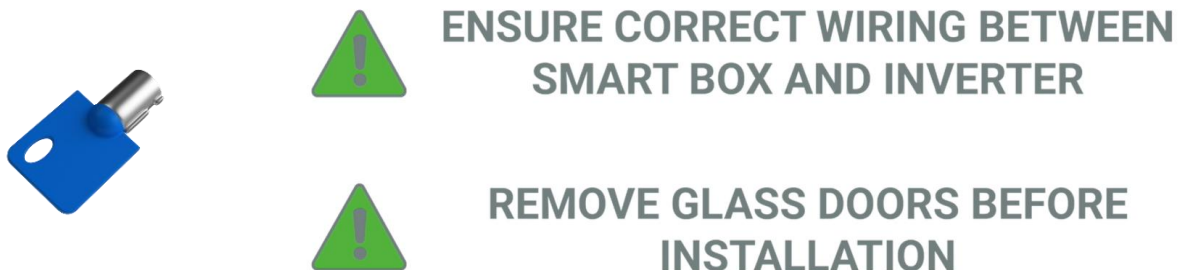

5.2. Requirements for the installation location

Ensure that the installation location fulfils the following conditions:

- The surface consists of solid materials
- The surface is suitable for the weight and dimensions
- The installation location is always accessible
- The installation location is not near to hot surfaces such as radiators or other appliances
- The installation location is not exposed to direct sunlight or rain
- The installation location is protected from splashing water
- The technical connection conditions of the grid operator are adhered to
- The installation location is not in potentially explosive areas
- The installation location is not in areas where highly flammable materials are stored
- Please avoid direct sunlight, rain and snow during installation and operation:

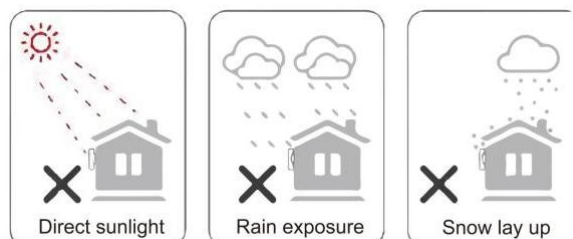

5.3. Required tools

The following tools are required to install the Smart Box:

Screwdriver



Electric drill (with 8mm drill bit set)



Spirit Level



Insulation stripping pliers



Multimeter



Crimping pliers for ferrules



5.4. Assembly Steps

Step 1: Preparation to mount the Smart Box on the wall

- Select the location where you want to install the Smart Box. Attach the Box to the wall and mark the position for the 4 holes:

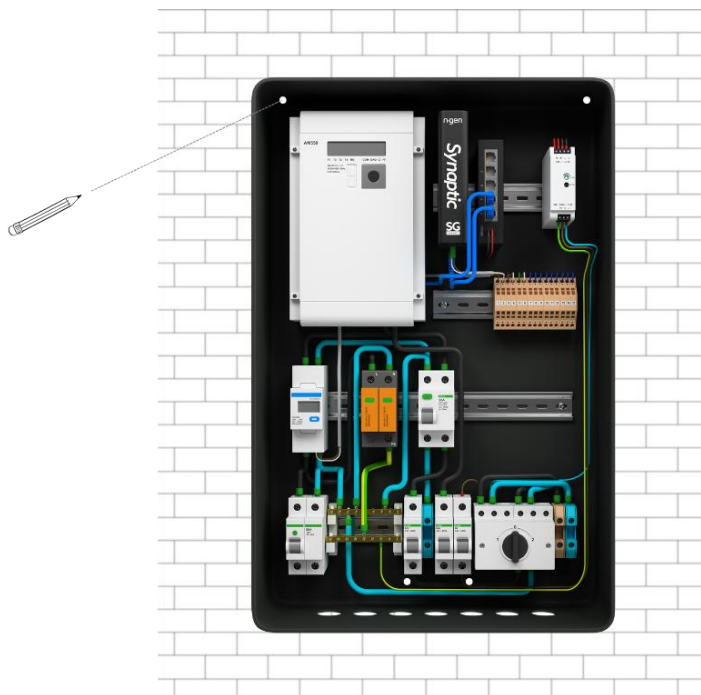



Warning!

Before drilling, make sure that the water and electricity lines in the wall are not damaged at the installation site of the Smart Box to avoid hazards.

- Drill the holes with an electric drill and make sure that the holes are at least 50mm deep and 8mm wide. Then fit suitable dowels in the pre-drilled holes:

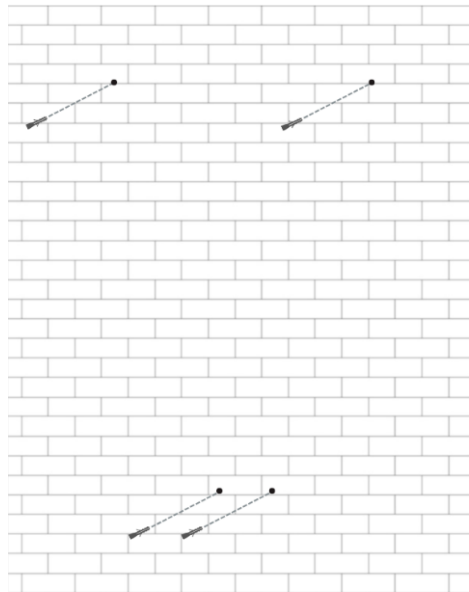

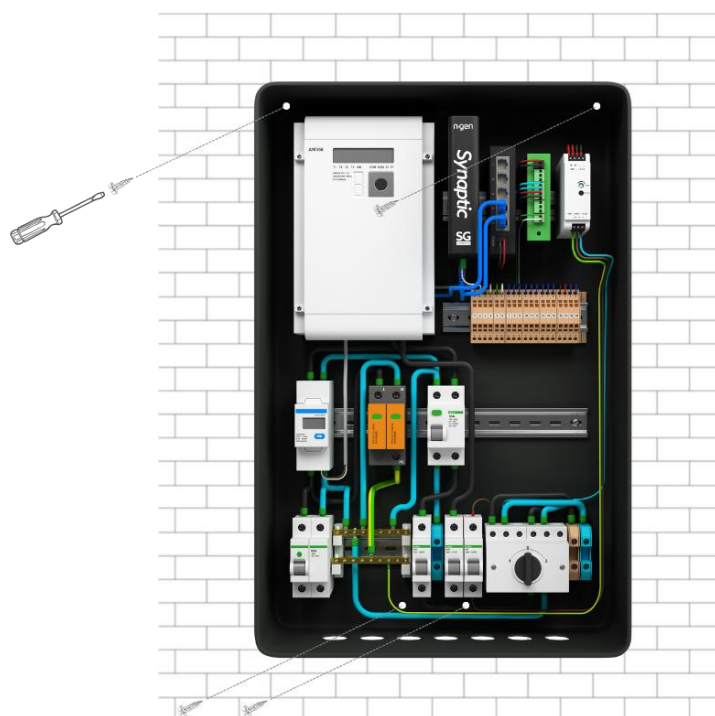

Step 2: Mount the Smart Box on the wall

- Mount the Smart Box on the Wall. Please use suitable screws and washers to fix the Box properly on the wall:
-



6. Electrical Connection

The Smart Box A163 / B163 are designed for three-phase grid connections. The voltage range is 220/230/240V, the frequency is 50/60Hz. Other technical requirements must comply with the requirements of the local public grid.

	<p>Warning! Before you start with the electrical connection of the Smart Box, disconnect the main entry fuse of the house, the circuit breakers, and the RCD from all phases and secure it against reconnection!</p>
	<p>Note! Please note the local cable type, cable cross-section, and colours for the actual installation. Before connecting the Smart Box to the AC-Grid, check the grid voltage and compare it with the permissible voltage range.</p>

6.1. Cable entries and fittings

Please use the pre-drilled holes on the underside of the Smart Box for the cable entry.

	<p>Note! The required cable fittings are not included in the delivery. Please use suitable cable fittings from the construction site that match the used cable cross-section.</p>
--	--

6.2. AC-Connection

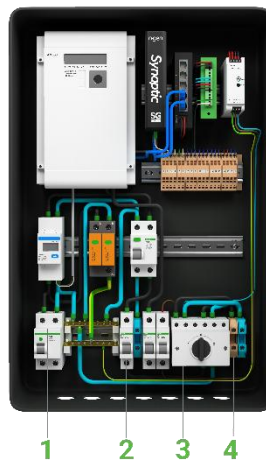

Number	Description
1	Input Grid
2	AC-Output Inverter
3	AC-Output Household loads
4	AC-Supply for Communication devices

	<p>Note! Please note the local cable type, cable cross-section, and colours for the actual installation. Before connecting the Smart Box to the AC-Grid, check the grid voltage and compare it with the permissible voltage range.</p>
---	---

6.3. Communication Connection

6.3.1. Smart Box A163

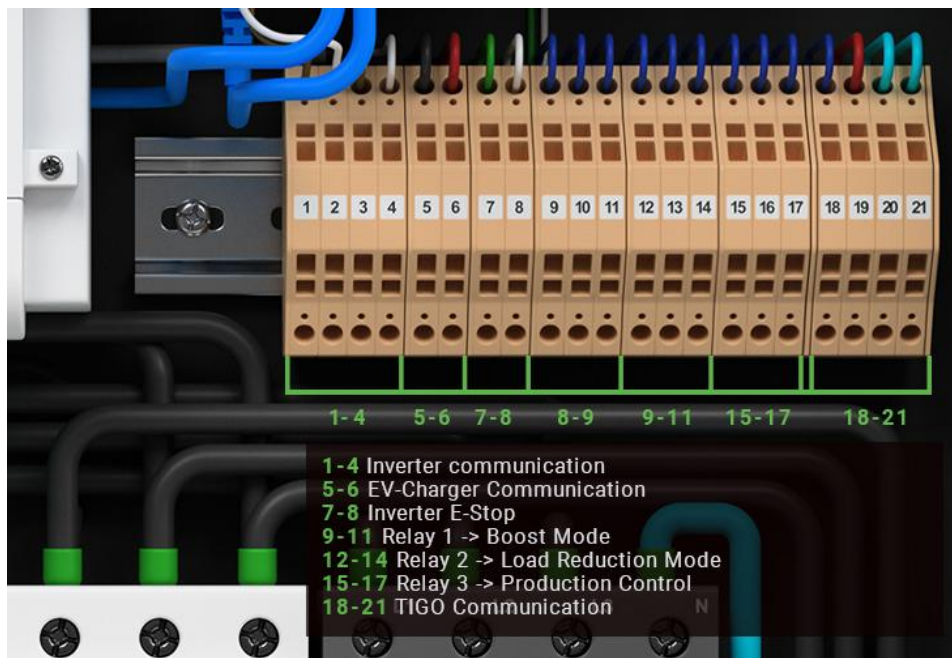

6.3.2. Smart Box B163

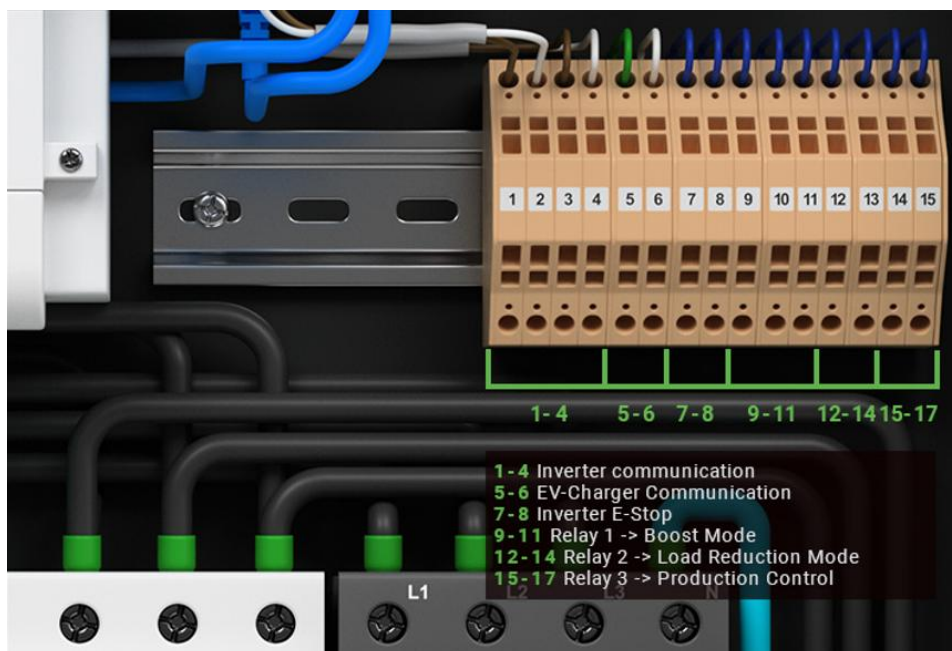

Note!

For the wiring of the communication terminals, please refer to the connection diagrams in section 6.5.

6.4. Internet Connection

Connect the Synaptic unit of the Smart Box to the customer's local internet router using an Ethernet cable. Connect the Ethernet cable from the internet router to the Synaptic unit as follows:

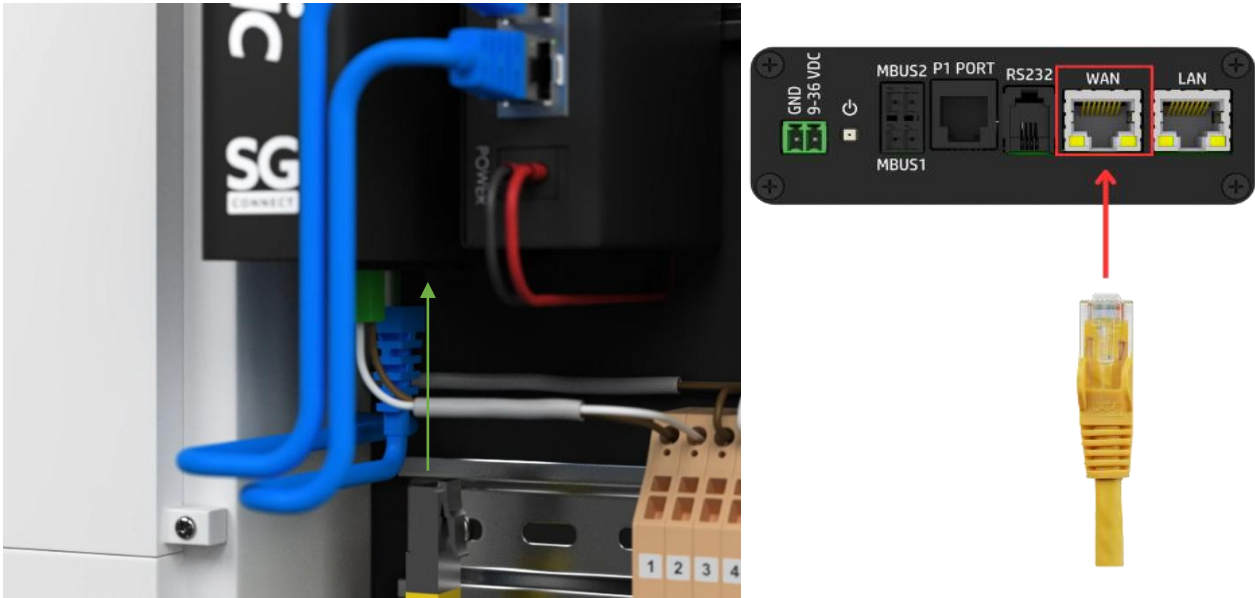

Note!
The port on the Synaptic-Unit for the internet connection is labelled "WAN".

6.5. Connection Diagrams

6.5.1. Connection Diagram NGEN-Star H1-Inverter

6.5.1.1. AC-Connection

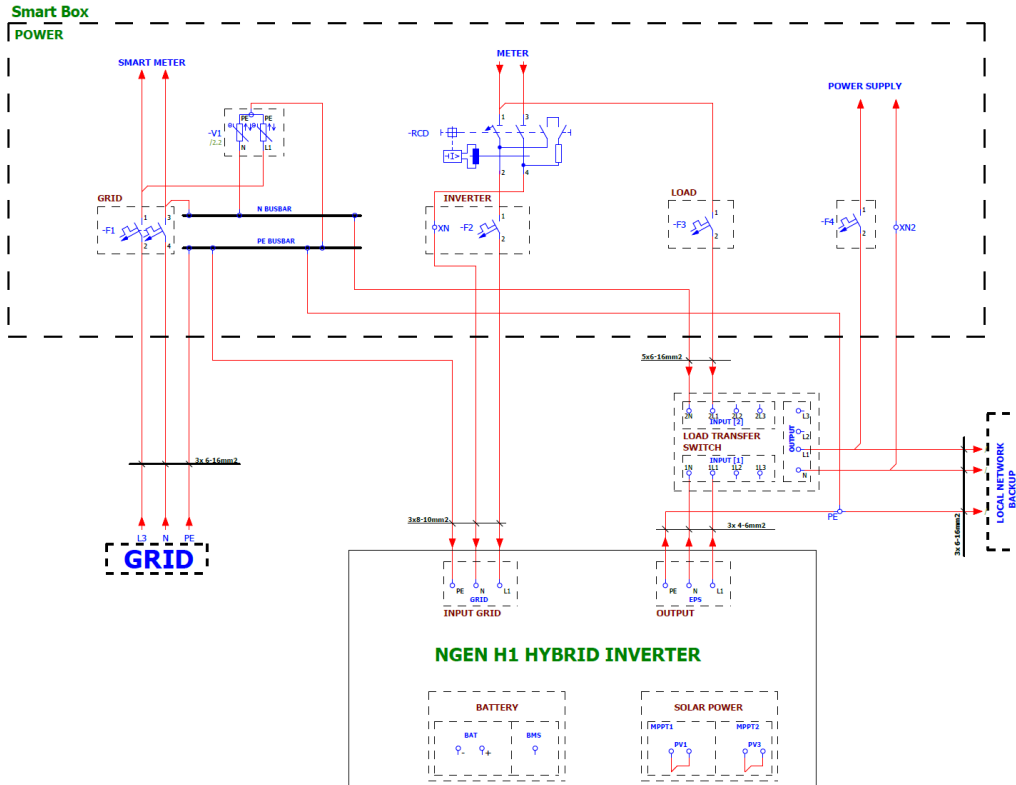

6.5.1.2. DC-Connection

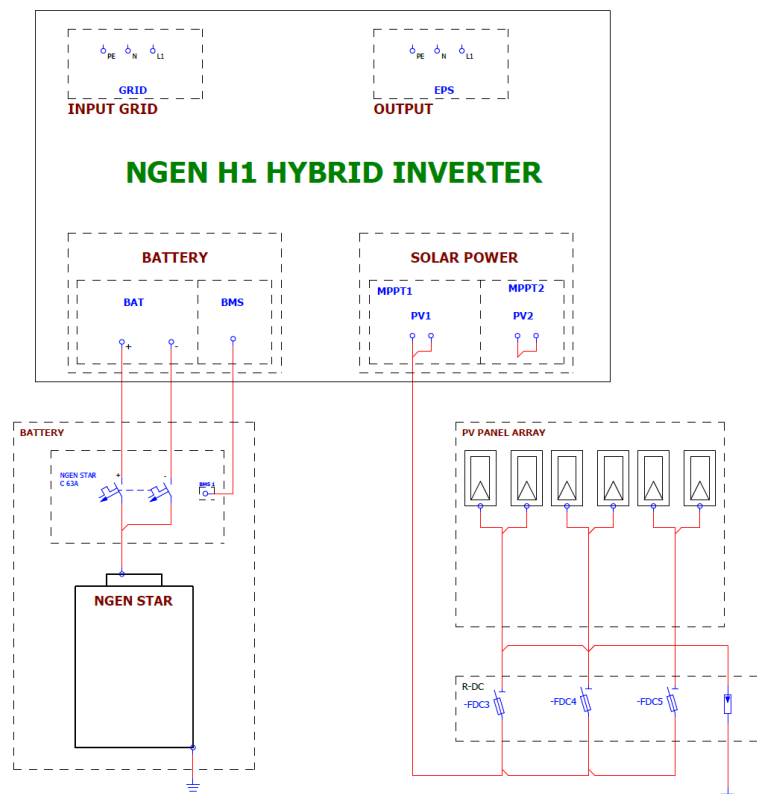

6.5.1.3. Communication-Connection

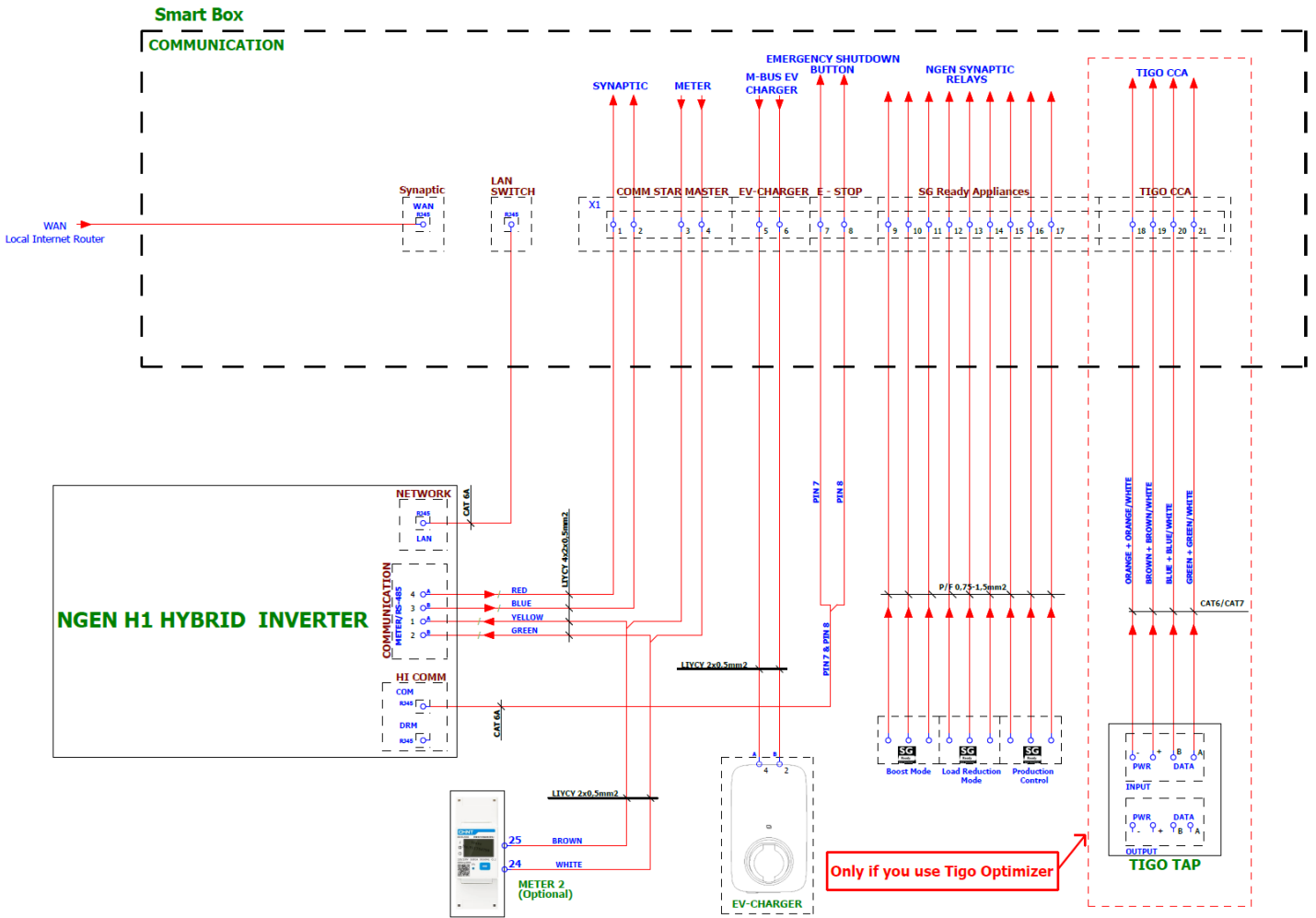

7. Function of the Synaptic relay outputs

For the connection of the relays as mentioned in section 6.3, please find below the explanations of the functions of each individual relay:

7.1. Relay 1 – Boost Mode

The Boost Mode allows you to take advantage of periods of low-cost or free electricity for devices that can store energy in the form of heat or increase consumption at certain intervals. This feature is ideal for heat pumps, electric heaters, and electric vehicles, which you can use when electricity is cheaper or free. With the Boost Mode, you will reduce your costs and increase energy efficiency by using energy when it is most advantageous. Especially when surplus energy from a photovoltaic system is used to optimize self-consumption.

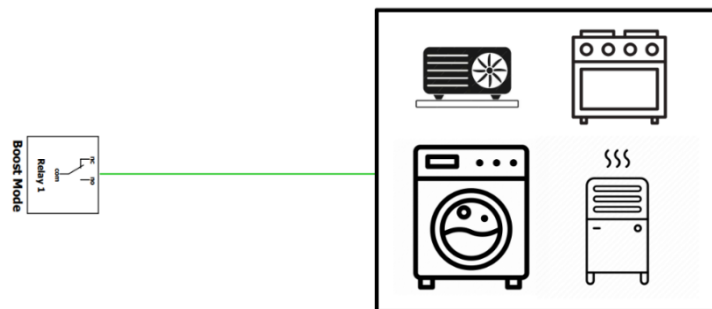

How It Works: Relay 1 is activated during intervals of reduced-price or free electricity.

Configuration: To enable this function, Relay 1 must be connected to your device so that the desired appliance turns on when the relay is activated. This allows automatic control of your device and maximizes the benefits of favourable electricity prices.

7.2. Relay 2 – Load Reduction Mode

The Load Reduction Mode is a feature that rewards you for energy-efficient behaviour. It encourages a reduction in electricity consumption by deactivating devices during times of high network load. This feature is ideal for devices such as heat pumps, electric heaters, and charging stations, which can be deactivated during periods when energy is expensive or when reducing consumption brings a reward.

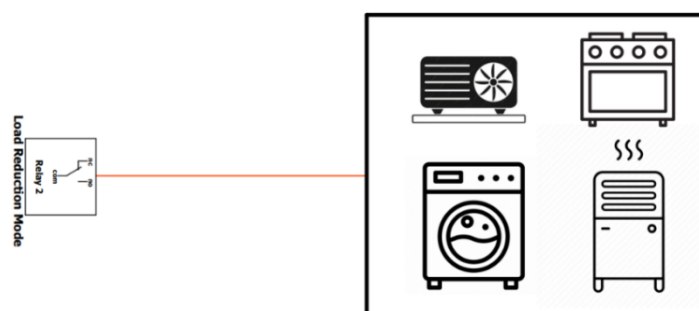

How It Works: Use devices connected to Load Reduction Mode (Relay 2) during these intervals to reduce your consumption. Receive a reward for participating in an energy-efficient program that helps stabilize the grid and reduce high network loads.

Configuration: To enable this function, Relay 2 must be connected to your device. When the relay is activated, your device will adjust to the optimal operating time, allowing you to save and earn rewards.

7.3. Relay 3 – Production Control

Production Control is a feature that helps you balance energy production and provides financial compensation for lost production. It is designed for users with solar power systems or other production units such as hydroelectric, wind or biomass plants that occasionally face disconnections or reduced production. With the Production Control, you can receive compensation for lost energy even when your system is not producing electricity for example during the activation of the negative tertiary reserves by the grid operator.

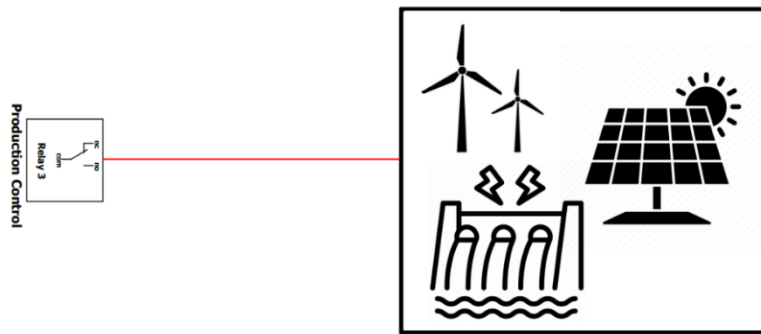

How It Works: In case of disconnections or reduced production, you receive simulated financial compensation for the lost energy.

Configuration: To enable this function, Relay 3 must be connected to your production unit, allowing monitoring and control of lost production. This way, you receive compensation and achieve a more stable return despite occasional interruptions.

8. Configuration of the Relais in the Smart Grid Connect App

After connecting the relay contacts to the intelligent devices, configuring the relays in the Smart Grid Connect app is necessary. Log in to the Smart Grid Connect app and open the desired system. Under the menu item Relay Control, you can perform the relay configuration. For all three relays, the user can define relay name and manually set time frames when the relay should be activated.

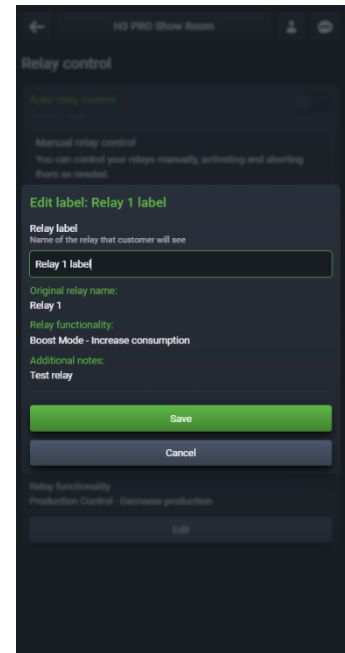
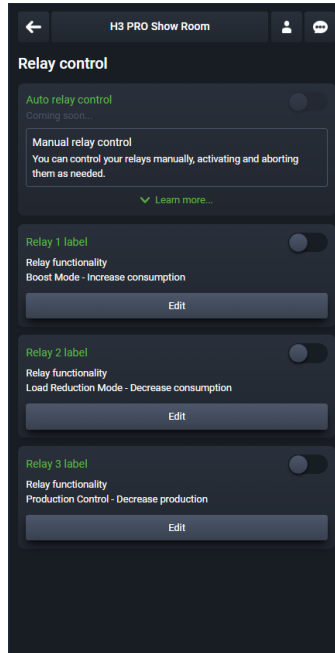

9. Shutdown Button Function

The Shutdown switch which is located on the front of the "Smart Box" unit, enables to stop the TIGO optimizers (if present) as well as the whole operation of the inverter quickly and safely in emergencies or during maintenance work. Pressing the Shutdown switch minimizes the risk of electric shocks or other issues related to electrical energy sourced from the inverter.



Use the Shutdown switch in the following situations:

- Before starting maintenance work to stop the operation of the inverter.
- In the event of fire
- If a battery is defective
- In all other hazardous situations that require the system to be switched off immediately.

Wait a few seconds after pressing the Shutdown switch, disconnecting the fuse for the AC supply of the inverter, and turning off the DC switch on the inverter and the battery to ensure the system is fully de-energized before beginning work on the components.

To restart the system, press the Shutdown switch again and wait 5 minutes until the system has fully booted up. If you notice any problems or irregularities, please contact NGEN technical support or an authorized service partner.

10. Shutdown Button with LED Indicator

The shutdown button on the door of the Smart Box is equipped with an LED indicator that visually displays the operating status of the Synaptic unit. The various colours and states of the LED have the following meanings:

- The LED light turns blue when the Synaptic unit is booting up after the power supply is switched on.



- The LED light remains solid blue when the Synaptic unit is running, and a LAN connection is established.



- The LED light flashes blue when the Synaptic unit is running via 4G, but no LAN connection is established.



- The LED light flashes red when the Synaptic unit has not internet connection via LAN or 4G.



11. Commissioning of the Smart Box

11.1. Requirements

- The Smart Box is securely mounted
- All required wires are correctly mounted and connected
- All inspections that must be carried out in advance according to national/local installation regulations have been completed
- All required insulation and function tests have been carried out.

11.2. Start-up Steps

- Step 1: Turn on the “Input Grid” circuit breaker
- Step 2: Turn on the “Output Loads” circuit breaker
- Step 3: Turn on the circuit breaker for the AC power supply to the communication devices
- Step 4: Turn on the RCD and the circuit breaker for the AC power supply to the hybrid inverter

	<p>Note! For information on how to start up the inverter, please refer to the relevant installation instructions for the inverter.</p>
---	---

11.3. Commissioning the Smart Box with the SG-Connect APP

Before you start commissioning the Smart Box, please download the "Smart Grid Connect" app from the App Store or Google Play Store:



	<p>Note! To log in to the Smart Grid Connect app successfully, valid login credentials are required. Each installer will receive these credentials via email after successfully completing a technical product training session from NGEN. For further questions, please contact the manufacturer.</p>
---	---

Follow the steps below to commission the Smart Box via the app:

Step 1: Open the SG Connect App and Add a new Device:

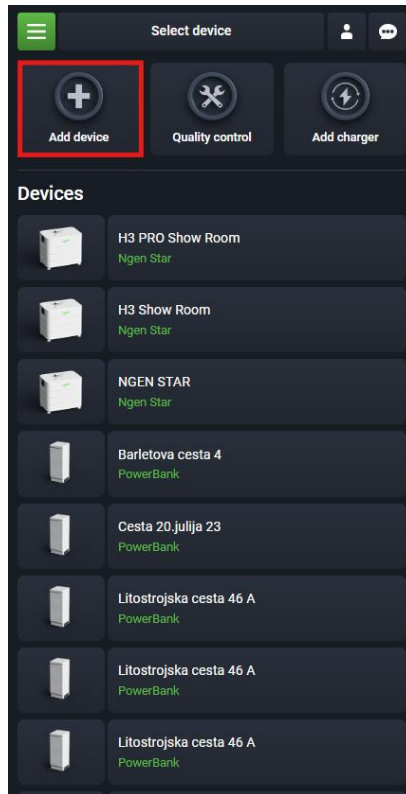

Step 2: Please select the installed hybrid inverter device:

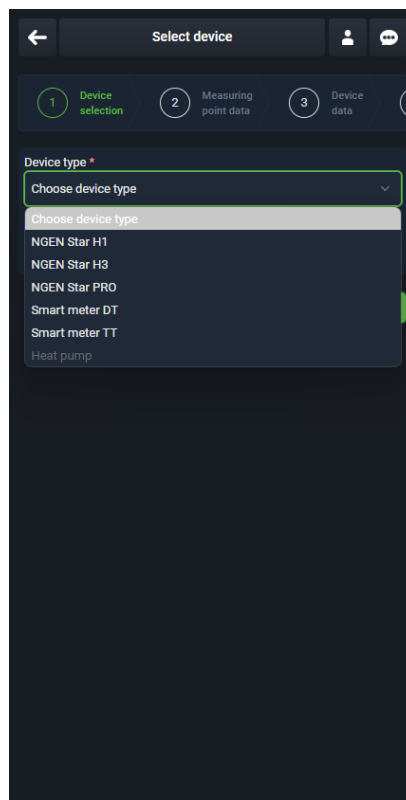

Step 3: Scan the QR-Code on the Synaptic-Unit to start the Commissioning process:



Step 4: Check the real-time energy flow diagram to ensure the system is operating properly:

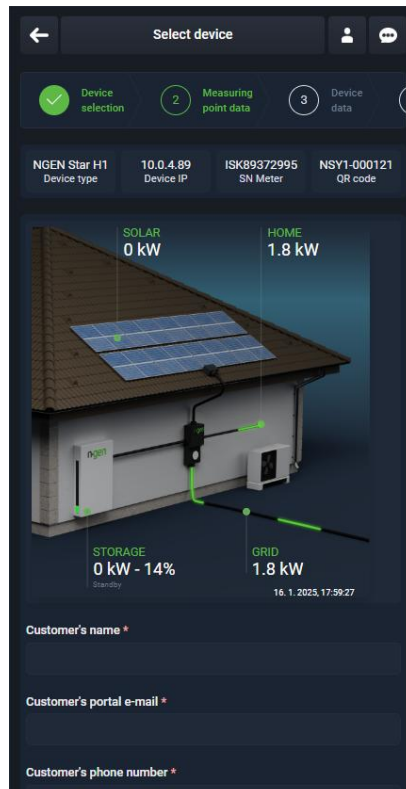

Step 5: Provide the following customer information:

- Customers Name
- Customers Portal E-Mail
- Customers Phone Number
- DNO Metering Point ID
- Connection Consent File for the Metering Point ID

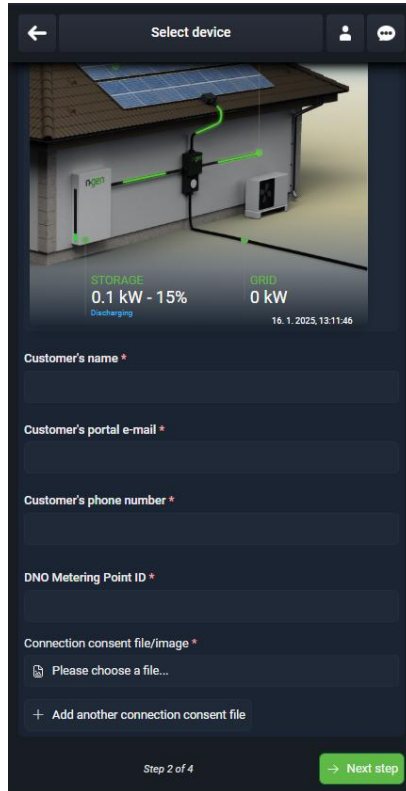

Note!

The customer's email address is required to enable monitoring access for the end customer. After the commissioning is completed, the end customer will receive an email from NGEN to create a password for their user account. Once the account is created, the customer can access the SG Connect app, and the system will automatically be visible.

Step 6: Scan the QR-Code from the Datalogger on the inverter and provide the costumer’s address:

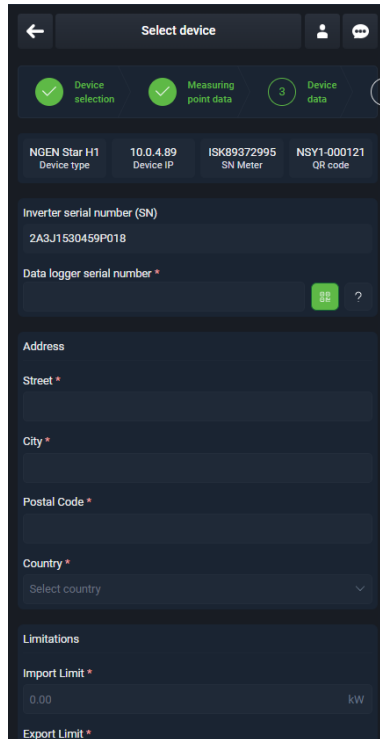

The screenshot shows the 'Select device' screen in a dark theme. At the top, there are three progress indicators: 'Device selection' (checked), 'Measuring point data' (checked), and 'Device data' (3/4). Below this, device information is displayed: 'NGEN Star H1' (Device type), '10.0.4.89' (Device IP), 'ISK99372995' (SN Meter), and 'NSY1-000121' (QR code). The 'Inverter serial number (SN)' is '2A3J1530459P018'. There is a field for 'Data logger serial number' with a QR code icon and a question mark. Below are fields for 'Address', 'Street', 'City', 'Postal Code', and 'Country' (with a dropdown menu). At the bottom, there are 'Limitations' fields for 'Import Limit' and 'Export Limit', both currently set to '0.00 kW'.

Step 7: Please provide the import and export limits from the local grid and include below additional information about the photovoltaic system:

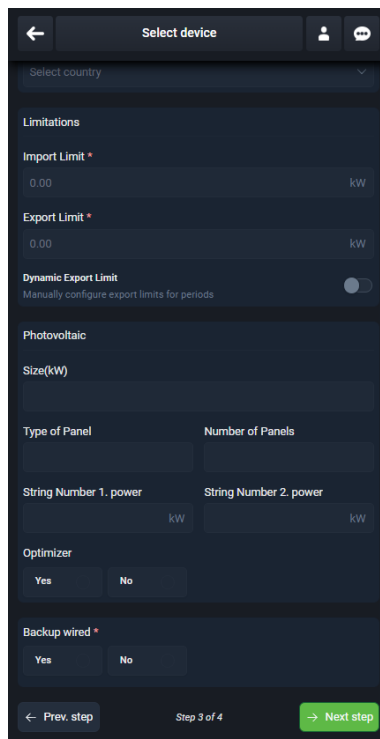

This screenshot shows the 'Select device' screen with the 'Photovoltaic' section expanded. It includes fields for 'Import Limit' and 'Export Limit', both set to '0.00 kW'. There is a 'Dynamic Export Limit' toggle switch which is currently turned off. The 'Photovoltaic' section contains: 'Size(kW)', 'Type of Panel' and 'Number of Panels' (two separate input fields), 'String Number 1. power' and 'String Number 2. power' (both in kW), 'Optimizer' (Yes/No buttons), and 'Backup wired' (Yes/No buttons). At the bottom, there are navigation buttons: '← Prev. step', 'Step 3 of 4', and '→ Next step'.

	<p>Note!</p> <p>Import Limit: This depends on the size of the main fuse in the house.</p> <ul style="list-style-type: none"> • Example: The Main Fuse is 35A – Please enter 8kW as the Import Limit <p>Export Limit: The export limit of excess photovoltaic energy depends on the approval of the grid operator.</p>
---	---

Step 8: Compare the live measurements from each phase in the app with the measurements from the CHINT Smart Meter. Additionally, please provide the required installation photos for documentation:

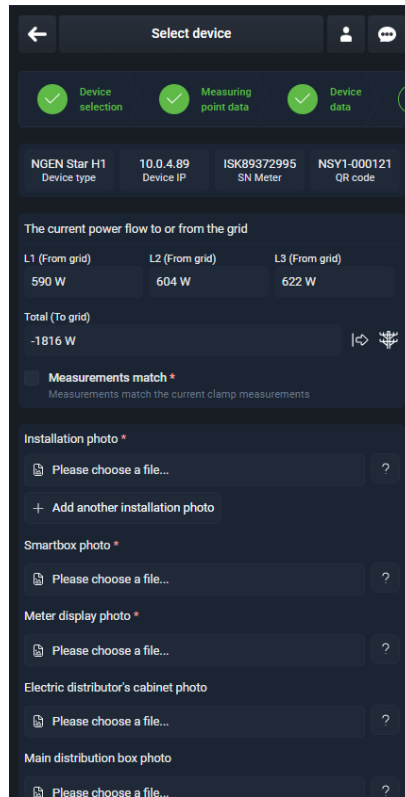

Step 9: Confirm and sign to complete the system commissioning:

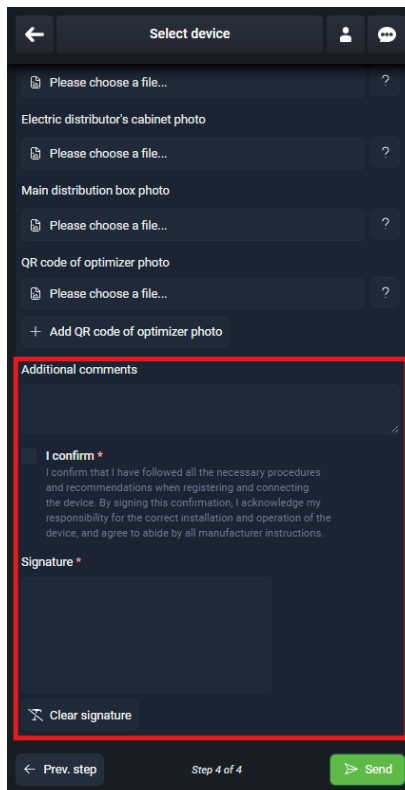

12. Maintenance and Cleaning

The Smart Box should be regularly checked for functionality and safety. Please observe the national regulations, which may vary from country to country. It is recommended to have the inspection carried out by a qualified electrician **once a year**.

- The installed residual current device (RCD) must be regularly checked by the system operator for its basic functionality (i.e., by pressing the 'test' button).

12.1. Cleaning the Smart Box

Depending on the installation location and environmental conditions, varying degrees of external contamination may occur. Clean the enclosure carefully with a damp cleaning cloth! Never open the enclosure, and only clean it with the door closed!

13. Storage

Requirements for the storage location:

- The storage location must be dry.
- The ambient temperature must be between -25°C and +55°C.
- Store the Smart Box in an environment where damage due external influences can be avoided.

14. Disposal

Dispose of the Smart Box in accordance with the current national and international regulations in the respective countries. The Smart Box must not be disposed of with household waste. In the European Union, the WEEE directive governs the handling of electronic waste, which is why proper disposal is carried out at recycling or waste collection companies.

15. Disclaimer

All warranty, liability, and compensation claims for damages of any kind are excluded if they are attributable to one or more of the following causes:

- Transport damage
- Improper or non-intended use of the product
- Operation of the product in an unsuitable environment
- Operation of the product without observing the relevant legal safety regulations at the installation site
- Failure to observe the warnings and safety instructions in all product-related documentation
- Unauthorized modifications or repairs to the product
- Natural events or force majeure.

The copyright of this manual belongs to NGEN d.o.o. No legal or physical person may copy this manual, either in part or in full (including software), nor is any distribution or reproduction of the manual in any form or manner permitted. All rights reserved by NGEN d.o.o., Moste 101, 4274 Žirovnica, Slovenia. www.NGEN.si